

8301 Paging Adapter & Scheduler FW version 1.7

User Guide



Order Codes

8301

Paging Adapter & Scheduler

Table of Contents

IMPORTANT SAFETY INFORMATION	4
OVERVIEW	6
INTRODUCTION.....	6
APPLICATIONS.....	7
SETUP AND INSTALLATION	8
GETTING STARTED - QUICK INSTALL & TEST.....	8
INSTALLATION.....	9
PROGRAMMING AND CONFIGURATION.....	9
FEATURES	10
SIP PAGING: ONE 8301.....	10
SIP PAGING: MULTIPLE ALGO SIP ENDPOINTS (USING MULTICAST).....	10
SIP PAGING: MULTIPLE ALGO SIP ENDPOINTS (USING INDIVIDUAL SIP EXTENSIONS).....	11
BACKGROUND MUSIC STREAMING.....	11
MULTICAST PAGE ZONES.....	11
SIP RING EVENT.....	13
SIP ACTIVATED NOTIFICATION ALERTS.....	13
POLYCOM™ GROUP PAGING.....	13
TLS FOR SIP SIGNALING AND PROVISIONING.....	14
WIRING CONNECTIONS	18
CONNECTING INPUT DEVICES TO 8301.....	18
BLUE LED INDICATORS.....	22
RESET.....	22
WEB INTERFACE STATUS AND LOGIN	23
WEB INTERFACE LOGIN.....	23
STATUS.....	24
WEB INTERFACE BASIC SETTINGS	25
BASIC SETTINGS TAB – SIP.....	25
BASIC SETTINGS TAB – FEATURES.....	27
BASIC SETTINGS TAB – MULTICAST.....	30
BASIC SETTINGS TAB – MULTICAST (MASTER SETTINGS).....	31
BASIC SETTINGS TAB – MULTICAST (SLAVE SETTINGS).....	34
WEB INTERFACE ADDITIONAL FEATURES	36
ADDITIONAL FEATURES TAB – INPUT/OUTPUT.....	36
ADDITIONAL FEATURES TAB – EMERGENCY ALERTS.....	41
ADDITIONAL FEATURES TAB – MORE PAGE EXTENSIONS.....	43
ADDITIONAL FEATURES TAB – MORE RING EXTENSIONS.....	44
WEB INTERFACE SCHEDULER	45
SCHEDULER TAB – CALENDAR.....	45
SCHEDULER TAB – SCHEDULES.....	46
SCHEDULER TAB – DATA.....	47

WEB INTERFACE ADVANCED SETTINGS.....	48
ADVANCED SETTINGS TAB - NETWORK.....	48
ADVANCED SETTINGS TAB – ADMIN.....	50
ADVANCED SETTINGS TAB – USERS.....	53
ADVANCED SETTINGS TAB – TIME.....	53
ADVANCED SETTINGS TAB – PROVISIONING.....	54
ADVANCED SETTINGS TAB – FILE MANAGER.....	56
ADVANCED SETTINGS TAB – ADVANCED AUDIO.....	57
ADVANCED SETTINGS TAB – ADVANCED SIP.....	59
ADVANCED SETTINGS TAB – ADVANCED MULTICAST.....	62
WEB INTERFACE SYSTEM.....	64
SYSTEM TAB - MAINTENANCE.....	64
SYSTEM TAB – SYSTEM LOG.....	65
SPECIFICATIONS.....	66
FCC COMPLIANCE STATEMENT.....	67

Important Safety Information

Important Safety Information

This product is powered by a certified limited power source (LPS), Power over Ethernet (PoE); through CAT5 or CAT6 connection wiring to an IEEE 802.3af compliant network PoE switch. The product is intended for installation indoors. All wiring connections to the product must be in the same building. If the product is installed beyond the building perimeter or used in an inter-building application, the wiring connections must be protected against over voltage / transient. Algo recommends that this product be installed by a qualified electrician.

If you are unable to understand the English language safety information then please contact Algo by email for assistance before attempting an installation support@algosolutions.com.

Consignes de Sécurité Importantes

Ce produit est alimenté par une source d'alimentation limitée certifiée (alimentation par Ethernet); des câbles de catégorie 5 et 6 joignent un commutateur réseau à alimentation par Ethernet homologué IEEE 802.3af. Le produit est conçu pour être installé à l'intérieur. Tout le câblage rattaché au produit doit se trouver dans le même édifice. Si le produit est installé au-delà du périmètre de l'édifice ou utilisé pour plusieurs édifices, le câblage doit être protégé des surtensions transitoires. Algo recommande qu'un électricien qualifié se charge de l'installation de ce produit.

Si vous ne pouvez comprendre les consignes de sécurité en anglais, veuillez communiquer avec Algo par courriel avant d'entreprendre l'installation au support@algosolutions.com.

Información de Seguridad Importante

Este producto funciona con una fuente de alimentación limitada (Limited Power Source, LPS) certificada, Alimentación a través de Ethernet (Power over Ethernet, PoE); mediante un cable de conexión CAT5 o CAT6 a un conmutador de red con PoE en cumplimiento con IEEE 802.3af. El producto se debe instalar en lugares cerrados. Todas las conexiones cableadas al producto deben estar en el mismo edificio. Si el producto se instala fuera del perímetro del edificio o se utiliza en una aplicación en varios edificios, las conexiones cableadas se deben proteger contra sobretensión o corriente transitoria. Algo recomienda que la instalación de este producto la realice un electricista calificado.

Si usted no puede comprender la información de seguridad en inglés, comuníquese con Algo por correo electrónico para obtener asistencia antes de intentar instalarlo: support@algosolutions.com.

Wichtige Sicherheitsinformationen

Dieses Produkt wird durch eine zertifizierte Stromquelle mit begrenzter Leistung (LPS – Limited Power Source) betrieben. Die Stromversorgung erfolgt über Ethernet (PoE – Power over Ethernet). Dies geschieht durch eine Cat-5-Verbindung oder eine Cat-6-Verbindung zu einer IEEE 802.3af-konformen Ethernet-Netzwerkweiche. Das Produkt wurde konzipiert für die Installation innerhalb eines Gebäudes. Alle Kabelverbindungen zum Produkt müssen im selben Gebäude bestehen. Wenn das Produkt jenseits des Gebäudes oder für mehrere Gebäude genutzt wird, müssen die Kabelverbindungen vor Überspannung und Spannungssprüngen geschützt werden. Algo empfiehlt das Produkt von einem qualifizierten Elektriker installieren zu lassen.

Sollten Sie die englischen Sicherheitsinformationen nicht verstehen, kontaktieren Sie bitte Algo per Email bevor Sie mit der Installation beginnen, um Unterstützung zu erhalten. Algo kann unter der folgenden E-Mail-Adresse erreicht werden: support@algosolutions.com.

安全须知

本产品由认证的受限电源 (LPS) , 以太网供电 (PoE) , 通过 CAT5 或 CAT6 线路联接至 IEEE 802.3af 兼容的 PoE 网络交换机供电。本产品适用于室内或建筑物周边安装。所有联接本产品的线路必须源自同一建筑物。本产品如需用于超出建筑物周边范围或跨建筑物的安装, 线路联接部分必须有过压和瞬态保护。Algo 建议本产品由专业电工安装。

如果您对理解英文版安全须知有问题, 安装前请通过电子邮件和 Algo 联系, support@algosolutions.com。

EMERGENCY COMMUNICATION

If used in an emergency communication application, the 8301 Paging Adapter & Scheduler should be routinely tested. SNMP supervision is recommended for assurance of proper operation. Contact Algo for other methods of operational assurance.

WET OR OUTDOOR ENVIRONMENTS

The 8301 Paging Adapter & Scheduler is intended for dry indoor locations only. For outdoor locations Algo offers weatherproof speakers and strobe lights.

CAT5 or CAT6 connection wiring to an IEEE 802.3af compliant network PoE switch must not leave the building perimeter without adequate lightning protection.

No wiring connected to the 8301 Paging Adapter & Scheduler may leave the building perimeter without adequate lightning protection.

Overview

Introduction

The 8301 Paging Adapter & Scheduler is a PoE SIP compliant and multicast capable IP adapter designed for integrating consumer, commercial, and professional audio amplifiers into an IP based Unified Communications environment for voice paging and notification. The 8301 is also a Scheduler. Relying on the NTP server, the 8301 can provide bells, tones, and customer service or emergency announcements for schools, retail, manufacturing, healthcare, etc. 1GB of memory is available in the device to store audio files, which can be played via the 8301 Line Out and, if desired, as a multicast to other Algo speakers, paging adapters and strobes.

Dual SIP extensions provide both voice paging and notification (ring) capability. One or both extensions can be registered with any Communication Server (hosted or enterprise) that supports 3rd party SIP Endpoints. Additional page and ring extensions are also supported, as well as Emergency Alert extensions.

Connection to the amplifier is made using a balanced and isolated line level output provided as both a XLR-mini connection and pluggable terminal block for twisted pair wiring.

Multiple adapters in a SIP environment require only one adapter to register as a SIP extension. Multicasting capabilities allow the SIP registered adapter to page and simultaneously stream multicast audio to the other adapters, Algo SIP speakers and strobes and third-party multicast compatible devices.

The 8301 Paging Adapter & Scheduler is configured using central provisioning features or by accessing a web interface using browsers such as Chrome, Firefox, or Edge.

What is Included

- 8301 Paging Adapter & Scheduler
- Wall mount bracket and screws
- Network cable
- Two pluggable terminal block for relay input and output
- Flat head screwdriver
- Getting Started Sheet

What is not Included

- Optional Wall Switch (Algo 1202, 1203, 1204, 1205)
- Optional 2504 Output Cable: XLR-Mini Female to XLR Male
- Optional 2505 Input Cable: XLR-Mini Male to XLR Female

Applications

- The 8301 Paging Adapter & Scheduler is typically used to connect an existing paging amplifier to a UC environment either as a SIP extension or multicast endpoint for voice paging, emergency alerting, night bell / loud ringing, bell scheduling and playing music. It provides a hybrid voice paging solution to integrate analog speaker infrastructure and multicast to Algo IP speakers, strobe lights and paging adapters, in addition to multicast supported IP telephones.

The Line output of the 8301 is connected directly to the dry audio input on an amplifier with an input impedance between 600 Ohm and 10 kOhm.

For amplifiers connected directly to the dry page port of an existing telephone system, the 8301 will provide a very similar interface providing both dry page audio and dry contact closure to activate the amplifier (if required).

For amplifiers connected to a FXS port of ATA through a “telephone answering device”, the 8301 will replace the answering device and eliminate the need for a FXS port or ATA. Please note the 8301 does not provide a FXS port interface.

- Notification alerting for emergency (e.g., lockdown, evacuation, reverse evacuation), safety (e.g., medical, workplace accident), security events (e.g. OSHA or similar workplace regulations).
- Scheduler for school bells, automated announcements for retail and healthcare, and workplace shift changes and breaks.
- Central multicasting device in Algo deployments where it is desired to locate an endpoint in a secure closet or location away from traffic areas.

Setup and Installation

Getting Started - Quick Install & Test



This guide provides important safety information which should be read thoroughly before permanently installing the product.

1. Connect the 8301 Paging Adapter & Scheduler to an IEEE 802.3af compliant PoE network switch or PoE Injector. The blue lights on the front will remain on until boot up is completed – about 30 seconds.
2. After the blue lights turn off, press the reset switch (RST) to hear the IP address over the analog outputs (e.g. headset can be connected to the green Aux output port). The IP address may also be discovered by downloading the Algo locator tool to find Algo devices on your network: www.algosolutions.com/locator
3. Connect the adapter Line Out to an amplifier using the mini-XLR connector or pluggable terminal block.
4. Access the 8301 Paging Adapter & Scheduler web page by entering the IP address into a browser (e.g. Chrome, Firefox or Edge) and login using the default password **algo**.
5. Enter the IP address or the domain name for the SIP server into the SIP Domain field under the **BASIC SETTINGS > SIP** tab.
6. Enter the credentials (SIP Extension, Authentication ID, and Password) for the Page and/ or Ring extension. Leave the credentials blank for either extension if there is no intended use to have both registered.

Note: The Authentication ID may also be called Username for some SIP servers, and in some cases may be the same as the SIP extension.

7. Verify the extension is properly registered with the SIP server in the Status tab. Ensure the SIP Registration is “Successful”.
8. Make a call to the adapter by dialing the registered SIP extension of the adapter from a telephone.

Installation

The 8301 is wall mountable in a horizontal orientation using the supplied bracket.



Example installation on 1/2" drywall:

Use appropriate drywall anchors for #8 screws, and pre-drill per anchor manufacturer's instructions. Insert 4 anchors into the wall, and then attach bracket to wall anchors using #8 screws. Snap the 8301 into the bracket.

Connect the 8301 to a PoE network switch.

Connect the audio output of the 8301 to an amplifier using either the mini-XLR output (male pins) or pluggable terminal block. The 8301 provides a dry audio output and dry contact closure.

An optional XLR output audio cable (Algo 2504) may be ordered for audio amplifiers that have standard XLR input connectors.

Programming and Configuration

The 8301 is configurable using the web interface or provisioning features.

After boot up, the blue lights on the front will turn off and the adapter will have obtained an IP address. If there is no DHCP server the 8301 will default to the static IP address **192.168.1.111**.

Press the reset switch (RST) to hear the IP address over the analog outputs (e.g. headset can be connected to the green output port). The IP address may also be discovered by downloading the Algo locator tool to find Algo devices on your network:

www.algosolutions.com/locator

Enter the IP address (e.g 192.168.1.111) into a browser such as Chrome, Firefox, or Edge. The web interface should be visible and the default password will be **algo** in lower case letters.

Features

SIP Paging: One 8301

The 8301 Paging Adapter & Scheduler can be registered as a third party SIP extension with a hosted or enterprise Communications Server supporting 3rd party SIP endpoints.

To register the adapter with the SIP server, use the **Basic Settings > SIP** tab in the web interface to enter the Communication Server IP address, extension, username, and password. This information will be available from the IT Administrator.

If VLAN is used, navigate to the **Advanced Settings > Network** tab to set VLAN options.

(Note, once the adapter is using VLAN you will need to be on the same VLAN to access the web interface.)

The adapter may now be accessed by dialing its assigned extension from a telephone, device, or client. The adapter will auto-answer, play the default pre-announce tone, and allow voice paging until disconnected.

There are a number of configurable adapter options:

- Increase or Decrease Speaker Volume
- Enable AGC (automatic gain control)
- Customize pre-announce tone file

The best voice paging quality and intelligibility will be obtained using the G.722 wideband audio codec. Most current IP telephones support G.722 which is sometimes referred to as “HD” voice or audio.

SIP Paging: Multiple Algo SIP Endpoints (Using Multicast)

Multicast features in the 8301 Paging Adapter & Scheduler require that only the first adapter be registered as a SIP extension. Additional Algo SIP endpoints, including any combination of paging adapters, speakers, and strobes, may be added as multicast Slaves receiving a stream from the SIP registered Master adapter, provided that only a single audio stream will be active at any given time across any or all of the devices. If multiple unique audio streams are needed simultaneously more than one Master device will be required.

The Master adapter will simultaneously stream audio to the Slave adapters. The Slave adapters do not require SIP extensions and do not need to register with the SIP Communication Server.

To enable multicast streaming from the Master adapter, go to the web interface and navigate to the **Basic Settings > Multicast** tab. Choose multicast mode ‘**Master/Sender**’ and pick ‘**All Call**’ for the Master single zone.

To enable multicast monitoring in the Algo SIP endpoint Slaves, go to the web interface for each endpoint and navigate to the **Basic Settings > Multicast** tab. This time though,

choose multicast mode '**Slave/Receiver**'. There is no need to select a zone as the endpoint will automatically monitor the '**All Call**' zone IP address.

The page pre-announce tone is generated from the Master. The speaker volume can be increased or decreased for each multicast Slave individually.



*Note: See "**Basic Setting Tab – Multicast**" section below for more configuration options and instructions.*

SIP Paging: Multiple Algo SIP Endpoints (Using Individual SIP extensions)

In some cases it may be desirable for every adapter to have a SIP extension. Multicast may still be used to page multiple Algo SIP endpoints, but each endpoint can also be called individually or generate a call when appropriately configured.

An Algo SIP endpoint configured as a SIP Multicast Slave will give its highest priority to a page using its SIP extension.

Communication Servers with the capability of dialing many SIP extensions simultaneously for paging may be able to create zones by calling "paging groups" in order to page telephone speakers in conjunction with speaker endpoints.

Background Music Streaming

The 8301 Paging Adapter & Scheduler, set as a Multicast master, can stream background music to other Algo slave devices on the network from a music source connected to the 8301's AUX Input. Note music may simultaneously be streamed through the local outputs.

When multicasting music, ensure that Automatic Gain Control (AGC) is 'Disabled' in **Basic Settings > Features** tab on all the slave devices. Meanwhile, on the Multicast master device, select 'G.722' for the Master Output Codec setting in **Advanced Settings > Advanced Multicast** tab.

Multicast Page Zones

The 8301 Paging Adapter & Scheduler supports nine 'basic' multicast zones. These zones are defined by the multicast IP addresses.

Somewhat arbitrarily, these zones are defined below but may be used in other ways. The important consideration is that there is a priority hierarchy – streaming activity on a zone higher on the list will be treated as a higher priority than a zone lower on the list – with music being the lowest priority.

- Priority
- All Call
- Zone 1
- Zone 2
- Zone 3
- Zone 4
- Zone 5

- Zone 6
- Music

There are two options for Paging to multiple zones: 'DTMF Selectable Mode' or via multiple page extensions.

The 'DTMF Selectable Mode' offers a dynamic page zone selection and requires only the Master device to have a registered SIP Extension. To page, dial the SIP extension of the Master device and then dial the desired DTMF page zone (e.g. 1, 2, etc.) on the keypad.

Note: DTMF codes for zones 10 and higher start with an "".*

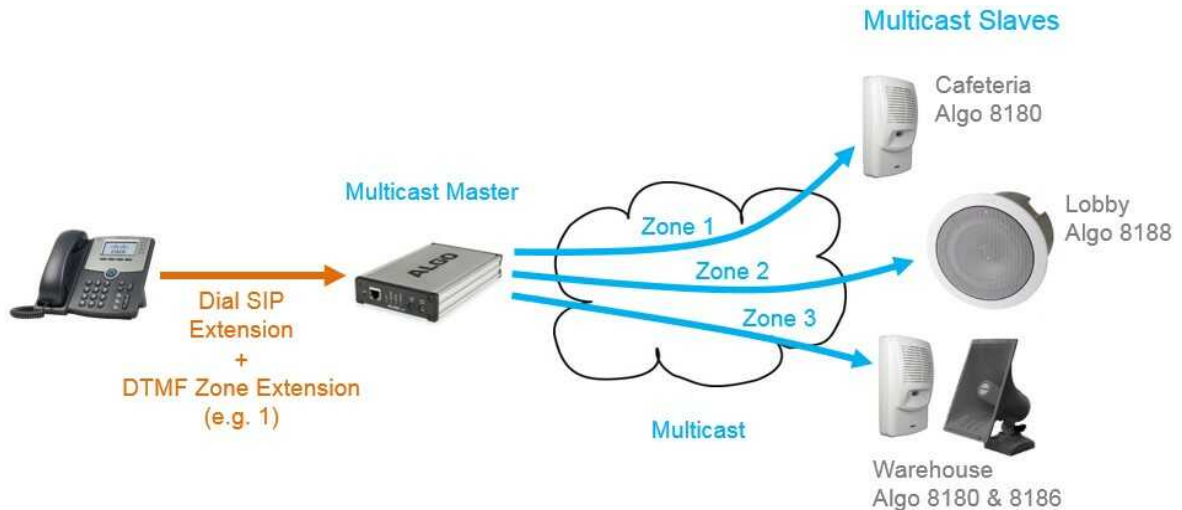

Alternatively, multiple SIP extensions can be registered on the Master device. Each extension is mapped to a unique zone, allowing zones to be called directly (for instance from speed-dial keys) without the use of DTMF. See **Additional Features > More Page Extensions** tab.

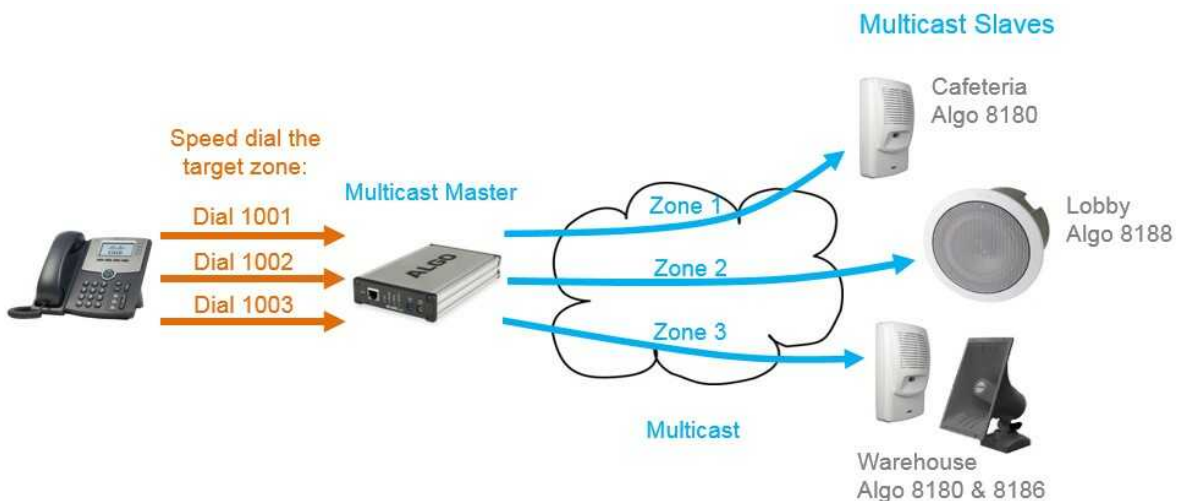

'Expanded' zones can also be enabled, allowing up to 50 zones in total. These have the same behaviours as the basic zones, but are hidden by default to simplify the interface.

SIP Ring Event

Set Monitoring Mode to 'Monitor "Ring" event on registered SIP extension' on the Basic Settings > SIP tab. When a call is made to the SIP extension the 8301 Paging Adapter & Scheduler will play the selected audio file from memory. Often, the 8301 will be part of a hunt group or ring group to ring in conjunction with a telephone.

SIP Activated Notification Alerts

In addition to voice paging, the 8301 Paging Adapter & Scheduler can play audio files for emergency, safety, and security announcements, customer service, shift changes, etc.

Audio files can be stored in memory and played over a speaker in response to an event such as a ring, relay input or automated schedule, and also multicast to other Algo SIP endpoints on the network. See **Additional Features > Emergency Alerts** and **Additional Features > Input / Output** tabs for more details.

Polycom™ Group Paging

The 8301 Paging Adapter & Scheduler has been designed to support Polycom Group Paging.

The 8301 can be added to a Polycom Group Page so that voice paging is heard over Polycom telephone speakers and overhead paging simultaneously.

Polycom Group Paging can be configured on the **Basic Settings > Multicast** tab.



The 8301 Paging Adapter & Scheduler may be accessed remotely via SIP and may generate a multicast page within the LAN sending voice page to both Algo paging speakers and Polycom telephones. Audio delay may be added to the 8301 to synchronize with voice page over the Polycom telephone speakers

TLS for SIP Signaling and Provisioning

Algo devices that support firmware 1.6.4 or later support Transport Layer Security (TLS). This feature adds security by ensuring that Algo products can trust the hosted SIP server. This is useful for when third-party devices or attackers may try to intercept, replicate, or alter Algo products, and try to connect to the server. TLS protocol will ensure that third parties cannot read/modify any actual data. Previously security was less of a concern because phone systems were on isolated networks, but hosted services are becoming increasingly more common. Using a hosted SIP service requires traffic to be sent over the public internet and thus much more susceptible to attacks. Signed certificates are an important piece in the Algo device's operation, to ensure the security, integrity, and privacy of its communication. Algo components that use TLS are **Provisioning** and **SIP Signaling**.

These Algo devices each come pre-loaded with certificates from a list of trusted certificate authorities (CA), which are installed in the hardware at the time of manufacture. Note these pre-installed trusted certificates are not visible to users and are separate from the 'certs' folder.

The TLS handshake happens to make sure that the client and server can trust each other, and once that trust is established, the two parties can freely send encrypted data and decrypt any data that they receive. After the TLS handshake process is complete, a TLS session is established, and the server and client can then exchange messages that are symmetrically encrypted with shared (pre-master) secret key.

For further details reference the [Algo TLS guide for SIP Signalling and HTTPS Provisioning](#).

Uploading Public CA Certificates to Algo SIP Endpoints

To install the public CA certificate on the Algo 8301, follow the steps below:

1. Obtain a public certificate from your Certificate Authority.
2. Rename the public certificate 'siptrusted.pem' (only .pem format is supported).
3. In the web interface of the Algo device, navigate to the **Advanced Settings > File Manager** tab.
4. Upload the certificate files into the 'certs' directory. Click the Upload button in the top left corner of the file manager and browse to the certificate.

For **SIP** TLS, no default public CA certificates are used; only the above .pem file is supported, so this certificate file must be uploaded in order for SIP TLS authentication to occur.

For **Provisioning** TLS, only the default pre-installed public CA certificates are supported; No .pem file can be uploaded in this case.

HTTPS Provisioning

Provisioning can be secured by setting the 'Download Method' to 'HTTPS' (under the **Advanced Settings > Provisioning** tab). This prevents configuration files from being read by an unwanted third-party. This resolves the potential risk of having sensitive data stolen, such as admin passwords and SIP credentials.

The screenshot shows the 'Provisioning Settings' page. At the top, there are navigation tabs: Status, Basic Settings, Additional Features, Scheduler, **Advanced Settings**, System, and Logout. Below these are sub-tabs: Network, Admin, Users, Time, **Provisioning**, File Manager, Advanced Audio, Advanced SIP, and Advanced Multicast. The main content area is titled 'Provisioning Settings' and contains several sections:

- Mode:** A dropdown menu set to 'Provisioning Mode' with radio buttons for 'Enabled' (selected) and 'Disabled'.
- Settings:**
 - Server Method:** Radio buttons for 'Auto (DHCP Option 66/160/150)', 'DHCP Option 66 only', 'DHCP Option 160 only', 'DHCP Option 150 only', and 'Static' (selected). A tooltip indicates: 'Auto mode automatically checks all 3 DHCP options for an active provisioning server, in the order listed.'
 - Static Server:** An empty text input field.
 - Download Method:** Radio buttons for 'TFTP', 'FTP', 'HTTP', and 'HTTPS' (selected).
 - Validate Server Certificate:** Radio buttons for 'Enabled' and 'Disabled' (selected).
 - Auth User Name:** An empty text input field.
 - Auth Password:** An empty password input field with a 'show/hide' icon.
 - Config Download Path:** An empty text input field.
 - Firmware Download Path:** An empty text input field.
 - Partial Provisioning:** Radio buttons for 'Enabled' and 'Disabled' (selected). A tooltip indicates: 'Allow support for "-i" incremental provisioning files. Disable for enhanced security if not using this feature.'

A green 'Save' button is located at the bottom right of the settings area.



Important: To verify the server 'Enable' the 'Validate Server Certificate' option. This then checks if the certificate that is provided by the server is signed by any of the CAs included in the list of trusted CAs (used by the Debian infrastructure and Mozilla browsers). If we receive a certificate signed by any of these CAs, then that server will be trusted.

The 'Validate Server Certificate' parameter can also be enabled through provisioning:

```
prov.download.cert = 1
```

SIP Signaling (and RTP Audio)

SIP signalling is secured by setting 'SIP Transportation' to 'TLS' (under the **Advanced Settings > Advanced SIP** tab). Setting it to 'TLS' ensures that the SIP traffic will be encrypted. The SIP signalling is responsible for establishing the call (the control signals to start and end the call with the other party), but it does not contain the audio.

For the audio (voice) path, use the setting '**SDP SRTP Offer**'. Setting this to '**Optional**', means the SIP call's RTP audio data will be encrypted (using SRTP) if the other party also supports audio encryption. If the other party does not support SRTP, then the call will still proceed, but with unencrypted audio. In order to make audio encryption mandatory for all calls, set '**SDP SRTP Offer**' to '**Standard**'. In this case, if the other party does not support audio encryption, then the call attempt will be rejected.

The screenshot shows the 'Advanced SIP Settings' configuration page. The navigation tabs at the top include Status, Basic Settings, Additional Features, Scheduler, **Advanced Settings**, System, and Logout. Under 'Advanced Settings', the sub-tabs are Network, Admin, Users, Time, Provisioning, File Manager, Advanced Audio, **Advanced SIP**, and Advanced Multicast.

Advanced SIP Settings

General

- SIP Transportation:** TLS (dropdown menu).
 - Info: Select Auto to check DNS NAPTR record, then try UDP/TCP.
 - Info: In TLS mode, if the SIP Server requires endpoints to be authenticated, a PEM file containing both a device certificate and a private key needs to be installed on the Algo device. Use the "Advanced Settings > File Manager" tab to upload a certificate file renamed to 'sipclient.pem' in the 'certs' folder.
 - Info: To force the Algo device to authenticate the SIP server, a certificate obtained from the SIP server needs to be installed. Use the "Advanced Settings > File Manager" tab to upload a certificate file renamed to 'siptrusted.pem' in the 'certs' folder.
- SIPS Scheme:** Enabled Disabled
- SDP SRTP Offer:** Standard (dropdown menu)
- SIP Outbound Support (RFC 5626):** Enabled Disabled
 - Info: Enable this option to support best networking practices according to RFC 5626. This option should generally be enabled if the Algo device is being registered with a hosted server or if TLS is being used for SIP Transportation.
- Outbound Proxy:** (empty text field)
- Register Period (seconds):** 3600 (text field)

NAT

- Media NAT:** None ICE STUN

Server Redundancy

- Server Redundancy Feature (Multiple SIP Server Support):** Enabled Disabled

Interoperability

- Keep-Alive Method:** None Double CRLF
 - Info: This setting will enable sending periodic CRLF messages for both UDP and TCP connections.
- Use Outgoing TLS port in SIP headers:** Enabled Disabled
 - Info: Use ephemeral port number from outgoing SIP TLS connection instead of listening port number in SIP Contact and Via headers. This is useful to connect the device to some local SIP servers, like Asterisk or FreeSWITCH.
- Do Not Reuse Authorization Headers:** Enabled Disabled
 - Info: When enabled, all SIP authorization information from the last successful request will not be reused in the next request.

Save



Important: In order for a SIP server to validate the Algo device, an additional certificate has to be manually installed on the 8301. To add this user certificate file use a '.pem' filetype extension and have the file named 'sipclient'. This is done by manually adding a file named 'sipclient.pem', which contains a device certificate and private key, to the 'certs' folder (under the 'Advanced Settings' tab File Manager). In the future, '.crt', '.cer', and '.der' certificate extensions will also be supported and you will not be restricted to naming the file 'sipclient.pem'.

Wiring Connections

The wiring diagram below illustrates one of the most common use cases, where the Line Output of the 8301 is connected directly to the dry audio input on an amplifier with an input impedance between 600 Ohm and 10 kOhm. The 8301 output level can be adjusted to match the amplifier's input specification. Check the Basic Settings -> Features section for more details. The optional dry contact closure can be used to activate the amplifier (if required).

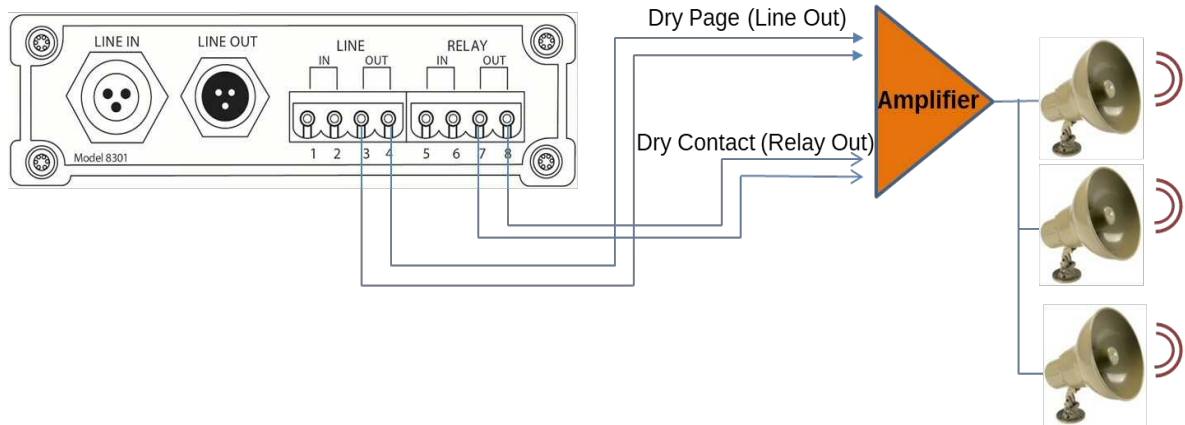

Connecting Input Devices to 8301

The relay input of the Algo 8301 Paging Adapter & Scheduler can be activated by any normally open or, normally closed switch, or one of several Algo input buttons/interfaces (e.g. 1202 Call Button, 1203 Call Switch, 1204 Volume Control Switch or 1205 Audio Interface). The input switches can be connected to the back of the 8301 via the Terminal Block on the 'Relay Input' pair. To configure the Relay Input Mode check the Additional Features > Input/Output section.

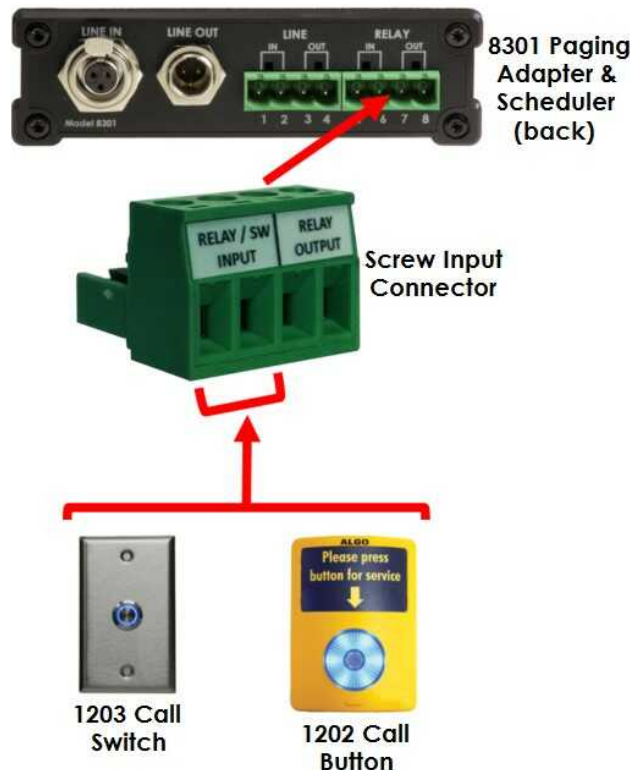

1202 Call Button

A pair of wires from the terminal block Relay Input on the back of the 8301 can connect to the **center pair** of the modular connector at the back of the Call Button. For more details check the [Algo 1202 Installation Sheet](#).

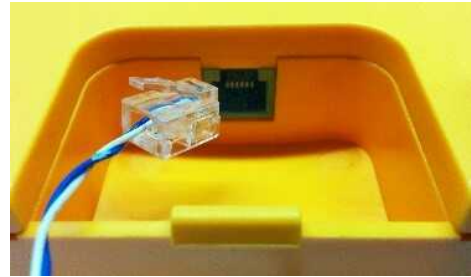

1203 Call Switch

A pair of wires can be run from the back of the device via a screw output connector to the 8301 via the Relay Input. For more details check the [Algo 1203 Getting Started Sheet](#).



1204 Volume Control Switch

Install the 1204 by connecting a single pair twisted wire to its terminal block (not polarity sensitive) and wire it to the Relay Input on the 8301. For more details check the [Algo 1204 Getting Started Sheet](#).

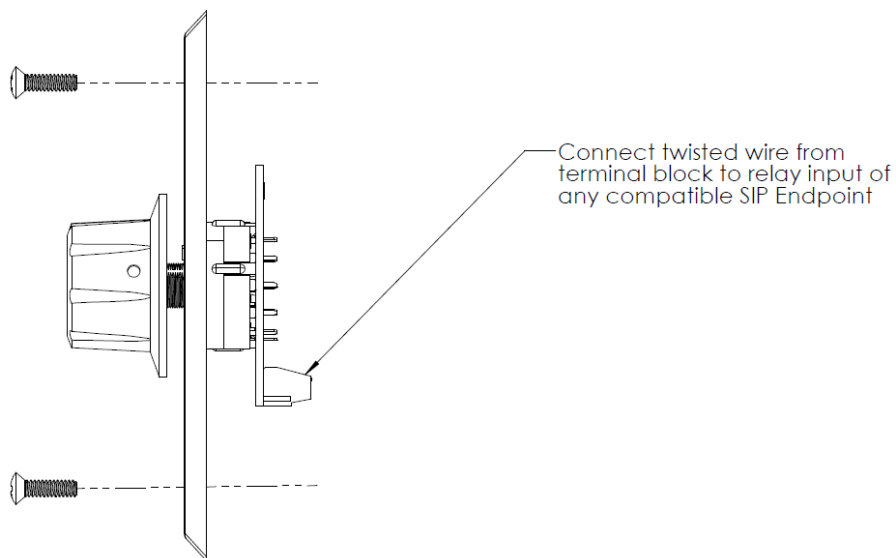

1205 Audio Interface

Two pairs of wires connect the 1205 Audio Interface to the 8301. One pair is for balanced audio and one pair is for communicating the rotary switch position.

Connect the 8301 Relay Input switch terminals of the 1205 Audio Interface to the “RELAY IN” of the 8301. Next, connect the Line In audio terminals of the 1205 Audio Interface to the Line In of the 8301. Neither pair is polarity sensitive. For more details check the [Algo 1205 Getting Started Sheet](#).

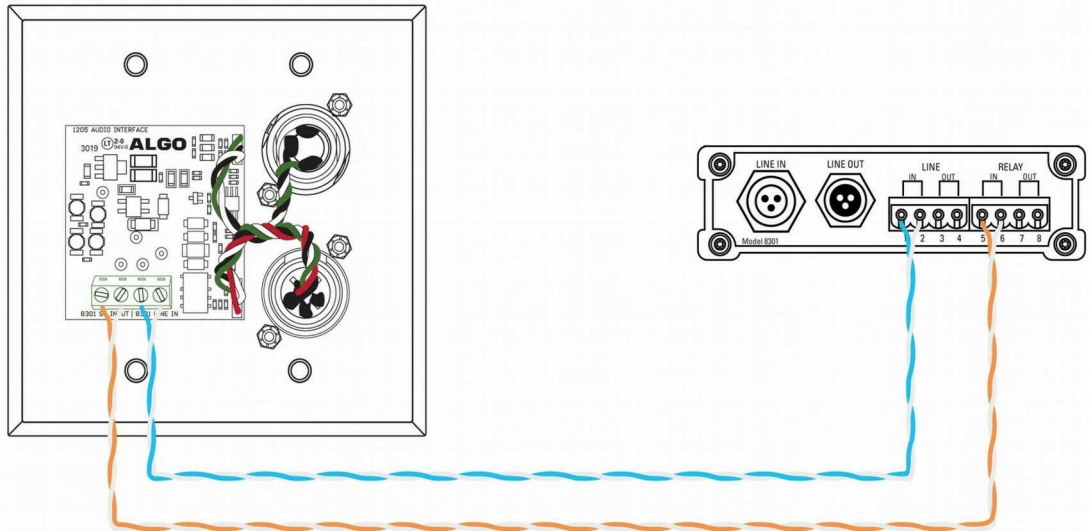

8301 Paging Adapter & Scheduler: Front View

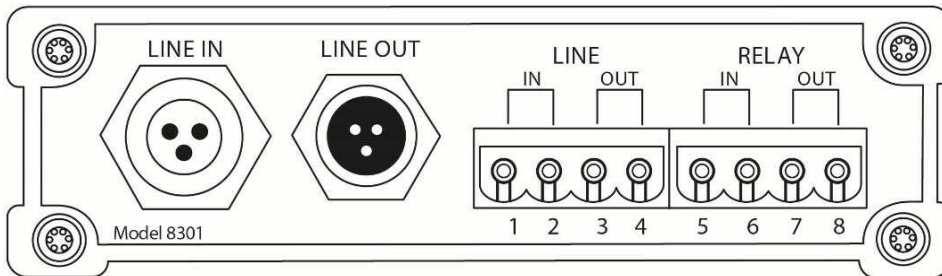

8301 Paging Adapter & Scheduler: Back View

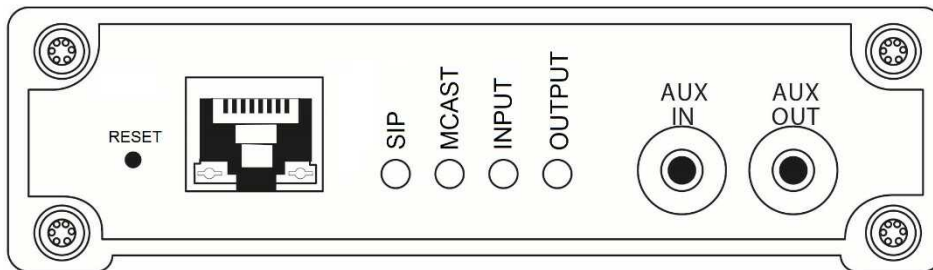

Network Connection

The 8301 provides a RJ45 jack for network connection. A cable run from the switch can be terminated to a modular jack with connection by patch cord, or terminated with a RJ45 plug.

PoE (Power over Ethernet) must be 48V 350 mA IEEE 802.3af compliant whether provided by the network switch or injector.

There are two lights on the Ethernet jack:

Green light: On when Ethernet is working, flickers off to indicate activity on the port.

Amber light: Off when successful 100Mbps link is established. Typically on only briefly at power up. (*Exception: the amber LED behaviour will be reversed on "RIs 1" hardware*)

Under normal conditions, the Amber light will turn on immediately after the Ethernet cable is first connected. This indicates that PoE power has been successfully applied. Once the device connects to the network, it will switch to the Green light instead, which will typically flicker indicating traffic on the network.

AUX IN (Front)

Analog line level input from iPod or similar device for music input. Non-isolated.

AUX OUT (Front)

Analog line level output for compatible PC speakers or headset. Non-isolated.

LINE IN XLR-MINI (Back)

Balanced and isolated audio (Page or music) input can be configured for pass-through to Line Out (when paging is idle), or for broadcast via multicast.

Line OUT XLR-MINI (Back)

Balanced and isolated audio output to external amplifier. Locking mini-XLR female to standard XLR male cable available. Output level defined using web interface.

Terminal Block Line In

Balanced and isolated wire pair input parallel to XLR-MINI LINE IN (polarity independent).

Terminal Block Line Out

Balanced and isolated wire pair output parallel to XLR-MINI LINE OUT (polarity independent).

Terminal Block Relay In

By default, these terminals are inactive. Connection options are a normally closed switch, normally open switch, 1202 Call Button, 1203 Call Switch, 1204 Volume Control Switch, 1205 Audio Interface or EOL resistor termination.

Terminal Block Relay Out

By default these terminals provide a contact closure when the 8301 Paging Adapter is active. Please note this is a normally open relay only.

Blue LED Indicators

All 4 blue lights will be on during power up and boot process.

SIP

Steady light will appear when the SIP extension is registered. The light will blink when the device is engaged in a SIP page/ring.

MCAST

Steady light will appear when 8301 receives multicast messages as a Slave. The light will blink when 8301 sends output to the Slaves as a Master.

INPUT

The input light is 'on' when the device is actively using an analog input port, based on the configuration set in the web interface and the active state (it does not detect a physical connection to the audio jack).

OUTPUT

Output light is on when analog output is enabled.

Reset

A recessed reset button (RST) next to the Ethernet Jack can only be used to reset the 8301 Paging Adapter & Scheduler at time of power up. To return all the settings to the factory default for the 8301, reboot or power cycle the 8301. Wait until the SIP LED flashes and then press and hold the reset button until the SIP LED begins a double flash pattern. Release the reset button and allow the unit to complete its boot process.

Do not press the reset button until the SIP LED begins flashing.

A reset will set all configuration options to factory default including the login password.

Once booting has completed, pressing the reset button will cause the device to speak its IP address over the analog output ports.

Web Interface Status and Login

Web Interface Login

Status
Basic Settings
Additional Features
Scheduler
Advanced Settings
System
Logout

Device Status

Welcome to the Algo 8301 Paging Adapter & Scheduler Control Panel

Setting up your Paging Adapter & Scheduler:

Step 1: Configure your Paging Adapter & Scheduler

Log in with the default password and use the Basic Settings pages to set up the basic information.

Step 2: Check network settings (Optional)

Use the Network page under the Advanced Settings tab to change network settings. The default setting for the device is to obtain its IP address from a DHCP server. Contact your Network System administrator if you plan to assign a static IP address, Mask, and Gateway to the device.

Step 3: Secure your Paging Adapter & Scheduler (Optional)

Use the Admin page under the Advanced Settings tab to change the administrator password.
⚠ Changing the password is extremely important if the device is directly connected to a public network.

Step 4: Register your Paging Adapter & Scheduler (Optional)

Please register your product using the link below:
<http://www.algosolutions.com/register>

Registration ensures your access to the latest upgrades to this product and important service notices.

Status

Device Name	pagingadapter	
SIP Registration	Page	No Account
Call Status	Idle	
Proxy Status	Single proxy mode	
Security	TLS	Disabled
	SRTP	Disabled
Provisioning Status	None Found	
MAC	00:22:ee:09:1e:71	
IP	10.30.25.55	
Netmask	255.0.0.0	
Gateway	10.0.1.1	
Date / Time	Tue Feb 18 23:39:22 UTC 2020	
Next Scheduled Event	No Events Scheduled	
Multicast Mode	Disabled	
Volume	Page Volume: 10 (0dB)	
Relay Input Status	Disabled	

The web interface requires a password which is **'algo'** by default. This password can be changed in the **Admin** tab after logging in the first time.



Web Interface is accessed by entering 8301's IP Address into the web browser.



Important: It is highly recommended to change the default password if the device is directly connected to a public network.

Status

The device's Status page will be available before and after log on. The section can be used to check 8301's SIP Registration status of the SIP extensions, Call Status, Proxy Status, Multicast Mode/Status, and general MAC, IP, Netmask, and Date/Time information.



*The Status page can be hidden when logged out for security purposes under the **Advanced Settings > Admin** tab.*

Web Interface Basic Settings

Basic Settings Tab – SIP

SIP Server information and Credentials should be obtained from your telephone system administrator or hosted account provider. After saving the settings, see the Status tab to confirm the registration was successful.



Important: Anytime changes are made to settings in the web interface the **'Save'** button must be clicked to save the changes.

SIP Domain (Proxy Server)

The IP address (e.g. 192.168.1.111) or domain name (e.g. myserver.com) of the SIP Server.

Ring / Alert Mode

Option for adding a second SIP extension for Ring event. If activated, screen expands to enter SIP extension parameters for a Ring/Alert Extension.

The device will detect inbound ring events on this extension and play the alerting tone (and multicast if configured) until the inbound call stops ringing. It will not answer the call on this extension.

Ring Extension

This is the SIP extension for the 8301's Ring parameter.

Page Extension

This is the SIP extension for the 8301's Page parameter. The device will auto-answer any inbound call received on this extension and provide a voice paging path (and multicast if configured).

Authentication ID

May also be called Username for some SIP servers and in some cases may be the same as the Ring and/or Page extension.

Authentication Password

SIP password provided by the system administrator for the SIP account.

Display Name

Enter a "Display Name" that will be sent when the SIP call is made. The PBX and phone(s) will have to be configured to display this message as the Caller ID.

Basic Settings Tab – Features

Status
Basic Settings
Additional Features
Advanced Settings
System
Logout

SIP
Features
Multicast

Features

Inbound Ring Settings

ⓘ These settings apply to events triggered by the Ring Extension(s) & Emergency Alerts sections. The Play/Loop/Stop buttons can also be used to test the device and set the appropriate volume level.

Ring/Alert Tone	warble2-med.wav	Play	Loop	Stop
Ring/Alert Volume	4	Apply		
Ring Limit	No limit			

ⓘ 1 ring = 6 seconds.

Inbound Page Settings

Page Speaker Volume	4	Apply	
<small>ⓘ When in Slave mode, note that this is the default volume control for all audio received via multicast.</small>			
Page Mode	<input checked="" type="radio"/> One-way <input type="radio"/> Two-way <input type="radio"/> Delayed		
<small>ⓘ "Delayed" mode stores the page audio temporarily, and then broadcasts it after the call is hung-up. This can help avoid feedback.</small>			
Page Timeout	5 minutes		
<small>ⓘ Maximum page timeout in Delayed mode is 5 minutes.</small>			
Page Tone	<Default>		
<small>ⓘ Use only Default, or custom uploaded file. The other pre-installed tone files all contain silence at the end in order to generate ring "cadence" of 6 seconds. This silence will block the voice path for several seconds at the start of a page.</small>			
G.722 Support	<input checked="" type="radio"/> Enabled <input type="radio"/> Disabled		
<small>ⓘ Applies to codec used during SIP negotiation only. Multicast codec is configured separately.</small>			
DTMF Detection Type	<input type="radio"/> Auto <input checked="" type="radio"/> RTP Telephony Event (RFC 4733) <input type="radio"/> RTP In-band <input type="radio"/> SIP INFO		

Audio Processing

Ambient Noise Compensation	<input type="radio"/> Enabled <input checked="" type="radio"/> Disabled
<small>ⓘ Automatically adjust speaker level in response to ambient noise level detected at the device prior to start of each call.</small>	
Automatic Gain Control (AGC)	<input checked="" type="radio"/> Enabled <input type="radio"/> Disabled
<small>ⓘ Automatically maximize level of voice received from calling phone in order to make page volume more consistent.</small>	

✔ Save

Ring/Alert Tone

Select an audio file to play when a ring event is detected on the SIP Ring extension. The audio file may be played immediately to an associated speaker from the web interface for test purposes using the Play, Loop, and Stop buttons. During multicast, the device will broadcast an audio stream using the Master's selected ring tone.

Note: This is the "Default" tone that will be played if selected for Multicast, Additional Ring Extension settings.

Ring/Alert Volume

Set speaker volume for SIP Ring event. This setting is an amplifier gain control and the output level will also depend on the levels recorded into the source audio file played from memory. This setting is only used for local tones, and not when receiving multicast (see Page Speaker Volume below).

Ring Limit

Typically set to no limit, this feature can be used to set a limit on how long the speaker will ring before timing out. A new ring event is required before the speaker will play the audio file again.

Page Volume

Speaker page volume control for SIP or multicast paging. This setting is an amplifier gain control and output level will depend on streaming level. This setting will apply to all inbound multicast stream (Slave mode only), regardless of content.

Page Mode

A call to the SIP page extension can be one-way, two-way using an external microphone, or delayed. In delay mode, the speaker will store the page into memory and then play after disconnect.

In delay mode, press "" to cancel a page while the recording state is in process to prevent it from being sent after hanging up.*

Page Timeout

A time limit may be set for an active page.

Page Tone

Select a pre-announce tone for paging. Use only Default, or custom uploaded files. The other pre-installed tone files all contain silence at the end in order to generate ring "cadence" of 6 seconds. This silence will block the voice path for several seconds at the start of a page. The "Default" tone will play the page-notif.wav file.



Note: The "Default Page Tone", in Advanced Multicast, will play the tone set here.

G.722 Support

Enable or disable the G.722 codec.

Passcode Protected Page Extensions

When enabled, the caller must enter the passcode followed by the # sign before the page can be accepted. Setting a passcode helps prevent unintentional pages.

Passcode

Only visible when 'Passcode Protected Page Extensions' is set to 'Enabled'. Enter the desired numerical passcode (maximum length of 15 digits).

Passcode Prompt Tone

Only visible when 'Passcode Protected Page Extensions' is set to 'Enabled'. Select the tone to be played to notify the user to enter the passcode before paging.

DTMF Detection Type

Select the preferred DTMF detection method.

Automatic Gain Control (AGC)

Normalizes the audio level. This ensures audio level heard at the speaker is always at a consistent level, independent of the phone that is used to answer the call.

'Line Out' Analog Output Level

The following output levels are available, allowing the 8301 to interface with a wide variety of devices:

+4dBu 10k (1.23 Vrms)
0dBu 10k (0.775 Vrms)
0dBV 10k (1.0 Vrms)
-10dBV 10k (0.316 Vrms)
0dBm 600 ohm (0.755 Vrms)
-10dBm 600 ohm (0.245 Vrms)
-20dBm 600 ohm (0.077 Vrms)

Basic Settings Tab – Multicast

Multicast IP Addresses

Each 8301 Paging Adapter & Scheduler has its own IP address, and shares a common multicast IP and port number (multicast zone) for multicast packets. The master transmits to a configurable multicast zone, and the slave units listen to all the multicast zones assigned to them.

The network switches and router see the packet and deliver it to all the members of the group. The multicast IP and port number must be the same on all the master and slave units of one group. The user may define multiple zones by picking different multicast IP addresses and/or port numbers.

1. Multicast IP addresses range: 224.0.0.0/4 (from 224.0.0.0 to 239.255.255.255)
2. Port numbers range: 1 to 65535
3. By default, the 8301 Paging Adapter & Scheduler is set to use the multicast IP address 224.0.2.60 and the port numbers 50000-50008

Make sure that the multicast IP address and port number do not conflict with other services and devices on the same network.

Multicast Page Zones

The 8301 Paging Adapter & Scheduler supports nine “basic” multicast zones. These zones are defined by the multicast IP addresses.

Somewhat arbitrarily, these zones are defined below but may be used in other ways. The important consideration is that there is a priority hierarchy – streaming activity on a zone higher on the list, will be treated as a higher priority than a zone lower on the list – with music being the lowest priority.

1. Priority
2. All Call
3. Zone 1
4. Zone 2
5. Zone 3
6. Zone 4
7. Zone 5
8. Zone 6
9. Music

“Expanded” zones can also be enabled, in the **Basic Settings > Multicast** tab, allowing up to 50 zones in total. These have the same behaviors as the basic zones, but are hidden by default to simplify the interface.

Basic Settings Tab – Multicast (Master Settings)

Status
Basic Settings
Additional Features
Scheduler
Advanced Settings
System
Logout

SIP
Features
Multicast

Multicast Settings

Multicast Mode

Multicast Mode None Master/Sender Slave/Receiver
 ⓘ Multicast Zone Definitions can be found in "Advanced Settings > [Advanced Multicast](#)".

Multicast Type Regular (RTP)
 Polycom Group Page
 Polycom Push-to-Talk
 Regular RTP + Polycom Group Page
 Regular RTP + Polycom Push-to-Talk
 ⓘ Regular mode uses RTP audio packets compatible with all Algo SIP endpoints, and most multicast-enabled phones.
 ⓘ Both "RTP + Polycom" multicast types will enable local speaker playback for all groups and zones.

Number of Zones Basic Zones Only Basic and Expanded Zones

Master/Sender Zone Settings

Zone Selection Mode DTMF Selectable Zone Single Zone
 ⓘ For additional capabilities allowing unique SIP extensions per zone, see "Additional Features > [More Page Extensions](#)".

Master Single Zone Zone 1
 ⓘ If "DTMF Selectable Zone" is selected above, then this single zone setting will not apply to Paging (since the zone can now be dynamically selected per call using DTMF), but it will still apply to the Ring Extension and Relay triggered events, including the analog audio input.

Speaker Playback Zones
 Priority Call All Call Music
 Zone 1 Zone 2 Zone 3
 Zone 4 Zone 5 Zone 6
 ⓘ Allows master device to play audio for selected zones only. This is useful if using DTMF Selectable Zone mode (or [More Page Extensions](#) per zone) and wishing to make the Master unit a member of only certain zones.

Expanded Speaker Playback Zones
 Zone *10 Zone *11 Zone *12 Zone *13 Zone *14
 Zone *15 Zone *16 Zone *17 Zone *18 Zone *19
 Zone *20 Zone *21 Zone *22 Zone *23 Zone *24
 Zone *25 Zone *26 Zone *27 Zone *28 Zone *29
 Zone *30 Zone *31 Zone *32 Zone *33 Zone *34
 Zone *35 Zone *36 Zone *37 Zone *38 Zone *39
 Zone *40 Zone *41 Zone *42 Zone *43 Zone *44
 Zone *45 Zone *46 Zone *47 Zone *48 Zone *49
 Zone *50

Select All
Clear All

DTMF Tone Settings

Zone Selection Tone <Default>

✔ Save

Note: See ([Advanced Settings > Advanced Multicast](#)) section for more information on populated IP values.

Multicast Mode (Master/Sender Selected)

If master mode is enabled the 8301 will broadcast an IP stream when activated in addition to playing the audio. (Note that the 8301 cannot be both a multicast Master and Slave simultaneously).

Number of Zones

Select “Basic Zones Only” if configuring nine or fewer multicast zones (shown beside “Speaker Playback Zones”) or select “Basic and Expanded Zones” to configure up to 50 zones. The expanded zones have the same behavior as the basic Slave zones, but are hidden by default to simplify the interface.

Multicast Type

The 8301 Paging Adapter & Scheduler may broadcast multicast paging, compatible with Polycom “**on premise group paging**” protocol and most multicast-enabled phones that use RTP audio packets.

Select “Regular” if solely multicasting to Algo SIP endpoints and/or multicast-enabled phones.

To multicast page announcements solely to Polycom phones, select “Polycom Group Page” or “Push-to-Talk”. Then, configure the 8301 with the “Polycom Zone” (IP Address and Port) and “Polycom Default Channel”.

Note: always ensure that the multicast settings on all Slaves match those of the Master.

Select “Regular RTP + Polycom Group Page/Push-to-Talk” to multicast page audio to both Polycom phones, Algo SIP endpoints, and multicast-enabled phones.

Polycom Group Selection Mode

“Single Zone” always broadcasts on one pre-configured Polycom Group. In “DTMF Selectable Zone” mode, the group is determined by the DTMF selection between 1 – 50.

Zone Selection Mode

‘Single Zone’ mode always broadcasts on one IP address. Note that multiple SIP extensions can be registered on the Master device. Each extension is mapped to a unique zone, allowing zones to be called directly (for instance from speed-dial keys). See **Additional Features > More Page Extensions** tab.

‘DTMF Selectable Zone’ mode, offers dynamic zone selection and requires only the master device to have a registered SIP Extension. The zone definitions can be found in the **Advanced Settings > Advanced Multicast** tab.

In ‘DTMF Selectable Mode’, to page, dial the SIP extension of the master device: #####, then dial the desired DTMF page zone (e.g. 1, 2, etc.) on the keypad when prompted.

1. Press DTMF Extension 9 for Priority Call
2. Press DTMF Extension 0 (or 8) for All Call
3. Press DTMF Extension 1 for Zone 1...
4. Press DTMF Extension *10 for Zone 10

5. Press DTMF Extension *11 for Zone 11...



Note: DTMF codes for zones 10 and higher start with an “”*

Zone Selection Tone

Only visible when ‘Zone Selection Mode’ is set to ‘DTMF Selectable Zone’. The tone played over the phone to prompt the user to select a zone to multicast to.

Master Single Zone

The zone that multicast stream will be sent to. If ‘DTMF Selectable Zone’ is chosen above, this setting will not apply to Paging, since the zone now must be dynamically selected per call via DTMF. However, the specified ‘Master Single Zone’ setting is still used for any multicast events triggered by the Ring, analog input, or the relay input.

Speaker Playback Zones

Allows Master device to play audio for selected zones only. This is useful if using DTMF Selectable Zone mode (or More Page Extensions per zone) and wishing to make the Master unit a member of only certain zones.

Basic Settings Tab – Multicast (Slave Settings)

The screenshot displays the 'Multicast Settings' configuration page. At the top, there are navigation tabs: Status, Basic Settings (selected), Additional Features, Scheduler, Advanced Settings, System, and Logout. Below these is a sub-tab for 'SIP Features' with 'Multicast' selected. The main content area is titled 'Multicast Settings' and is divided into several sections:

- Multicast Mode:** Radio buttons for 'None', 'Master/Sender', and 'Slave/Receiver' (selected). A note indicates that Multicast Zone Definitions can be found in 'Advanced Settings > Advanced Multicast'.
- Multicast Type:** Radio buttons for 'Regular (RTP)' (selected), 'Polycom Group Page', and 'Polycom Push-to-Talk'. A note states that Regular mode uses RTP audio packets compatible with all Algo SIP endpoints.
- Number of Zones:** Radio buttons for 'Basic Zones Only' and 'Basic and Expanded Zones' (selected).
- Slave/Receiver Zone Settings:**
 - Basic Slave Zones:** Checkboxes for 'Priority Call' (checked), 'All Call' (checked), and 'Music'. Below are checkboxes for 'Zone 1' (checked), 'Zone 2', 'Zone 3', 'Zone 4', 'Zone 5', and 'Zone 6'.
 - Expanded Slave Zones:** A grid of checkboxes for zones *10 through *50, all of which are currently unchecked.

At the bottom right of the form, there is a green 'Save' button.

Multicast Mode (Slave Selected)

If Slave mode is enabled the 8301 will activate when receiving a multicast message. It will mimic the audio stream, but use local volume settings ('Page Speaker Volume' in Basic Settings > Features).

Multicast Type - Regular

Select "Regular" if receiving multicast from other Algo SIP endpoint(s) and/or multicast-enabled phone(s) that use RTP audio packets.

Number of Zones

Select "basic" zones if configuring nine or fewer multicast zones or "expanded" to configure up to 50 zones. The expanded zones have the same behaviour as the basic slave zones, but are hidden by default to simplify the interface.

Multicast Type – Polycom Group Paging/Push-to-Talk

The 8301 Paging Adapter & Scheduler may receive multicast paging compatible with Polycom **"on premise group paging"** protocol.

To configure the 8301 as a slave to play Polycom page announcements, select “Group Page” or “Push-to-Talk”. Then enter the Polycom Zone (IP Address and Port) that matches the configuration of the Polycom phones and Channels. The “Default Channel” is the target group in a Polycom paging environment.

The screenshot shows the 'Multicast Settings' page with the following configuration:

- Multicast Mode:** None Master/Sender Slave/Receiver
- Multicast Type:** Regular (RTP) Polycom Group Page Polycom Push-to-Talk
- Polycom Zone:** 224.0.1.116:5001
- Polycom Slave Channels:**
 - Group 1 Group 2 Group 3 Group 4 Group 5
 - Group 6 Group 7 Group 8 Group 9 Group 10
 - Group 11 Group 12 Group 13 Group 14 Group 15
 - Group 16 Group 17 Group 18 Group 19 Group 20
 - Group 21 Group 22 Group 23 Group 24 Group 25

The Polycom phone used as page audio source for the 8301 Paging Adapter & Scheduler(s), must be configured to use either the G.711 or G.722 audio codec. **The Polycom phone(s) must also be configured with the “Compatibility” setting (“ptt.compatibilityMode”) disabled** in order for this codec setting to be applied.

If using a Polycom phone as the Multicast master, a tone may be set for any of the 25 Polycom Groups configured on the Algo device. If an Algo device is used as a Multicast master, a tone does not have to be set as the Algo master will provide its own tone. Polycom Group Tones can be set in Advanced Settings > Advanced Multicast tab.

Slave Zones

Select one or more multicast zones for the 8301 to monitor. Note that multicast zone priority is based on the zone definition list order (top to bottom) in the Advanced Settings > Advanced Multicast tab.

Web Interface Additional Features

Additional Features Tab – Input/Output

Status
Basic Settings
Additional Features
Scheduler
Advanced Settings
System
Logout

Input/Output
Emergency Alerts
More Page Extensions
More Ring Extensions

Input/Output

General

Relay Input Mode

- Disabled
- Relay Normally Open
- Relay Normally Open with Supervision (e.g. Algo 1203 Call Switch)
- Relay Normally Closed
- Relay Normally Closed with Supervision
- Mute Switch
- Mute Switch with Supervision
- Algo 1202 Call Button
- Algo 1204 Volume Control Switch
- Algo 1204 Volume Control Switch with Supervision

Audio Streaming

Audio Always On

Enabled Disabled

ⓘ "Audio Always On" will play sound on the Line Out and Aux Out ports as well as multicast if configured. Input port and volume can be configured below in the "Audio Input Settings" section.

Action When Input Triggered

Action

- Play Tone
- Make Two-Way SIP Voice Call
- Make SIP Call with Tone
- Stream Audio

ⓘ "Play Tone" and "Stream Audio" will play sound on the Line Out and Aux Out ports as well as multicast if configured.

Tone/Pre-recorded Announcement:

Tone Duration: Play Once Play While Held

Action When Tamper Detected

Action

- Play Tone
- Make Two-Way SIP Voice Call
- Make SIP Call with Tone

ⓘ "Play Tone" and "Stream Audio" will play sound on the Line Out and Aux Out ports as well as multicast if configured. Note that this action will occur 5 seconds after a wiring fault is detected. If the fault is resolved within 5 seconds, this action will not occur.

Tone/Pre-recorded Announcement:

Tone Duration: Play Once Play While Held

Output

Output Relay: Enabled Disabled

Relay Input Mode

The input relay to the 8301 Paging Adapter & Scheduler can be activated by any normally open or normally closed switch. Algo offers the 1202 Call Button, the 1203 Call Switch, 1204 Volume Control Switch or the 1205 Audio Interface with supervision. Via supervision settings, notification actions can also be triggered if the input switch is disconnected.

1203 Call Switch



The 1203 Call Switch is a simple contact closure switch with an illuminated button and supervision capabilities. When used in conjunction with the 8301, the 1203 can prompt a single action with one-touch, or a continuous action if the button is held.

Mute Switch

Apply an external switch (short-circuit) across the Relay Input terminals in order to mute the speakers connected to the 8301. This allows a temporary "disable" switch to control the device if desired, for example in a boardroom to block paging during important meetings.

Leave the Relay Input terminals open (no-connect) for regular full-volume operation when in this mode.

1202 Call Button



The 1202 Call Button is a one-touch button for event notification and response. It can be used with the 8301 for improved customer service, emergency notification, and non-emergency alerting. The Call Button's one-touch button can trigger a single or continuous action, which can be halted via the small cancel/reset button located below the main call button.

While the 8301 can be configured to play the audio file only once, it can also be enabled to play it continuously with just one touch on the 1202 Call Button. The action can then be stopped via the smaller oval cancel button located below the main call button on the 1202 Call Button.

1204 Volume Button



The 1204 Volume Control Switch is a simple 2 terminal potentiometer that will allow attenuation below the max volume level (configured under 'Basic Settings > Features').

Algo's 1204 can be used for variable volume control. The maximum volume should still be set in the Basic Settings > Features tab as usual, and then the Volume Control Switch will allow attenuation below this level. Enabling Priority Multicast Override allows priority multicast to override the volume set by the Volume Control Switch. Enabling 'Mute On Lowest Setting' allows audio to be completely muted when volume control switch is turned all the way down.

1205 Audio Interface

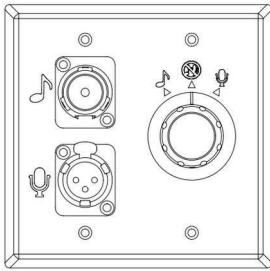

The 1205 Audio Interface provides a method for connecting a music source and live microphone to the 8301 Paging Adapter for multicast broadcast over the network to IP speakers or IP enabled legacy paging systems.

The Algo 1205 rotary control knob has three positions (music, microphone and off). The 8301 will automatically detect the control knob position to start multicast for either the microphone or music input as selected, or stop multicast in the off state.

The music input uses a 3.5mm stereo input jack compatible with Apple™ iPod™ and other sources. Left and right stereo channels are combined into a balanced mono signal compatible with public address infrastructure. The music volume is adjusted by both the Audio Input Volume setting in the web interface of the 8301 and manual adjustment of the source level.

The microphone input uses an XLR connector compatible with dynamic microphones such as the Sennheiser™ E835 and similar microphones that do not require phantom power.

Audio Always On

Primarily used to play background music, this feature will play sound on the Line Out and Aux Out ports as well as multicast if configured. The input port and volume can be configured below in the "Audio Input Settings" section.

Note: Audio Streaming Always On cannot be used when the relay trigger action is set to 'Stream Audio'. To enable Audio Streaming Always On, set Relay Input Mode to 'Disabled', or set Action When Input Triggered to 'Play Tone', 'Make Two-Way SIP Voice Call', or 'Make SIP Call with Tone'.

Action – Play Tone

When the 8301 input is triggered, a tone or a pre-recorded audio file will play over the speaker via the Line Out, or multicast if enabled. This function can be used to request support/assistance in service or retail environments, notify about an emergency at a specific location in medical or educational facilities, or sound an alarm during an intrusion.

- Action When Input Triggered:
 - Tone/Pre-recorded Announcement
 - Tone Duration

Action – Make Two-Way SIP Voice Call

When the 8301 input is triggered, a voice path will open for an intercom-like call via an external microphone (connected to AUX IN) to a pre-configured phone extension. This option can be used when a call needs to be made from a public place where a phone would not be practical to use.

- Action When Input Triggered:
 - Extension to Dial
 - Allow 2nd Button Press
- Outbound SIP Call Settings:
 - Outbound Ring Limit
 - Ringback Tone
 - Maximum Call Duration

Action – Make SIP Call with Tone

When the 8301 input is triggered, a private call can be generated to a pre-configured phone extension with a pre-recorded message. For instance, a call to a supervisor's phone notifying about an emergency or intrusion at some location.

- Action When Input Triggered:
 - Extension to Dial
 - Allow 2nd Button Press
 - Tone/Pre-recorded Announcement
 - Interval Between Tones (seconds)
 - Maximum Tone Duration
- Outbound SIP Call Settings:
 - Outbound Ring Limit

Action – Stream Audio

Will stream audio from audio input on a local speaker as well as multicast if configured.

Action When Tamper Detected (Supervision)

In addition to the main events, the device can be configured with supervision to also execute one of the above three actions ('Play Tone', 'Make Two-Way SIP Voice Call', 'Make SIP Call with Tone') in case the device goes offline due to wiring failure or after being tampered with. For example, a tone could sound over the speaker(s), or a private pre-recorded message could be sent to a specified phone extension. The supervision configuration options will appear once a relay option with supervision is selected. See the Electrical Specification section for details on supervision detection circuit.

Extension to Dial

SIP account required in Page Extension fields in order to make a call. Can be configured if 'Make SIP Voice Call' or 'Make SIP Call with Tone' actions are enabled under 'Call Button Settings'.

Interval Between Tones

Specify the time delay (seconds) between tones. Can be configured if 'Play Tone' or 'Make SIP Call with Tone' actions are enabled under 'Call Button Settings'.

Maximum Tone Duration

Select the maximum tone duration. The tone will be terminated once the maximum time is reached. Can be configured if 'Play Tone' or 'Make SIP Call with Tone' actions are enabled.

Allow 2nd Button Press

If enabled, 2nd button press will either simply End Call or End and Restart Call. Therefore, if an input is triggered for the second time the SIP call will either simply be terminated or terminated and immediately called again.

Outbound Ring Limit

Typically set to ensure that a call will not reach voicemail. This feature, under 'Outbound SIP Call Settings', can be used to set a limit on how long the speaker will ring before timing out.

Ring back Tone

If enabled, under 'Outbound SIP Call Settings', a ringback tone will play over the speaker during an outbound SIP call, while waiting for the far-end party to answer.

Audio Input Port

Select an audio input port for 'Audio Always On' or relay triggered 'Stream Audio' event. 'Aux Input' is the front blue 3.5mm jack for headsets (iPods/iPhones). 'Aux Output' is the front green 3.5mm jack for headset with microphone (headsets or PC speakers). 'Line Input' is the back terminal block and mini-XLR port.

Audio Streaming Volume

Speaker volume control for audio streaming.

Output Relay

Enable or disable the output relay terminal. Please note this is a normally open relay only.

Additional Features Tab – Emergency Alerts

Status Basic Settings **Additional Features** Scheduler Advanced Settings System Logout

Input/Output **Emergency Alerts** More Page Extensions More Ring Extensions

Emergency Alerts

i This section allows pre-recorded announcements to be triggered & latched by calling an extension and hanging up. The announcement will continue to play until a different "Cancel" extension is called to clear the announcement (or a pre-defined timeout is reached). This can be useful for emergency notifications (e.g. "Evacuation Alert"), allowing staff to quickly dial a pre-configured number and then exit the building. Audio files can be easily uploaded to create custom announcements.

i Up to 10 extensions can be registered allowing up to 10 different announcements. A single "Cancel" extension also needs to be registered; calling this number will cancel the currently active announcement.

i Note: Some SIP phone systems may not support this feature if they limit the number of extensions that can be registered on a single device.

Settings

Announcement Duration Play Once Play Until Cancelled

Maximum Announcement Time

Answer Inbound Call Enabled Disabled

i This option selects how the Announcement calls are handled. In both cases, the Emergency Announcement is started when the appropriate extension is called and continues until the Cancel Extension is called.

i Select "Enabled" to answer the inbound call and provide the option to play a confirmation tone before starting the alert, then automatically release the call.

i Select "Disabled" to detect just the inbound Ring signal, but not actually answer the call

Call-to-Cancel

Extension

Authentication ID

Authentication Password

Display Name (Optional)

Announcements

Announcement 1 Enabled Disabled

Announcement 2 Enabled Disabled

Announcement 10 Enabled Disabled

Emergency Alerts allow for an announcement to be triggered & latched by calling a pre-configured Emergency extension and hanging up. The announcement can be chosen to play once or to play until cancel. "Play Once" mode will play a single cycle of the chosen tone file, despite of its duration. If "Play Until Cancelled" is selected, the announcement will continue to play until the "Call-to-Cancel" extension is called to clear the announcement (or a defined timeout is reached). The Emergency Alerts are useful for emergency

notifications (e.g. evacuation, lock down, medical emergency, etc.), allowing staff to quickly dial a pre-configured number under such circumstances.

To configure an emergency alert extension click “Enable” beside the target announcement and enter the Extension, Authentication ID, and Authentication password.

If the “Answer Inbound Call” option is “Enabled” the call is auto-answered and a configurable confirmation tone is played before starting the alert. If “Disabled”, the alert is triggered just by the inbound ring, without answering the call. (In both instances, the announcement will play until the time limit is reached or the “Cancel Extension” is called). The auto-answering option can be useful when the caller cannot hear announcement from their location. However, in instances where the call might go to a group/multiple extensions (including this device), the auto-answer may intercept that call and prevent it from ringing on other devices.

Up to 10 extensions can be registered allowing up to 10 different announcements. Audio files can also be easily uploaded to create custom announcements. Only one "Call-to-Cancel" extension is needed, despite the number of the alert extensions.



Note: Some SIP phone systems may not support this feature if they limit the number of extensions that can be registered on a single device.

Additional Features Tab – More Page Extensions

Status
Basic Settings
Additional Features
Advanced Settings
System
Logout

Input/Output
Emergency Alerts
More Page Extensions
More Ring Extensions

More Page Extensions

This section allows dedicated extensions to be registered for each paging zone. This provides an alternative to the "DTMF Selectable Zone" option, thus allowing any zone to be called directly without the need to enter DTMF. Depending on the features available on your SIP phone system, this can provide benefits in allowing speed-dial keys to be programmed on user phones for paging a particular zone more easily, or dialing restrictions could potentially be used to allow only selected phones to access certain zones. This feature requires several SIP extensions to be registered with the SIP phone system.

- i The 8186 will auto-answer any inbound calls received on these numbers and provide a voice paging path and multicast if configured. Note that only a single call can be active at a time.
- i Note: Some SIP phone systems may not support this feature if they limit the number of extensions that can be registered on a single device.
- i Multicast Zone Definitions can be found in "Advanced Settings > [Advanced Multicast](#)".

Basic Extensions

Priority Call Page Extension	<input type="radio"/> Enabled <input checked="" type="radio"/> Disabled
All Call Page Extension	<input type="radio"/> Enabled <input checked="" type="radio"/> Disabled
Zone 1 Page Extension	<input type="radio"/> Enabled <input checked="" type="radio"/> Disabled
Zone 2 Page Extension	<input type="radio"/> Enabled <input checked="" type="radio"/> Disabled
Zone 3 Page Extension	<input type="radio"/> Enabled <input checked="" type="radio"/> Disabled
Zone 4 Page Extension	<input type="radio"/> Enabled <input checked="" type="radio"/> Disabled
Zone 5 Page Extension	<input type="radio"/> Enabled <input checked="" type="radio"/> Disabled
Zone 6 Page Extension	<input type="radio"/> Enabled <input checked="" type="radio"/> Disabled
Music Page Extension	<input type="radio"/> Enabled <input checked="" type="radio"/> Disabled

Expanded Extensions

Zone 10 Page Extension	<input type="radio"/> Enabled <input checked="" type="radio"/> Disabled
Zone 11 Page Extension	<input type="radio"/> Enabled <input checked="" type="radio"/> Disabled

Additional SIP extensions can be registered for each multicast zone that will be used. This allows the advantage of dialing directly to a zone without needing to enter DTMF Codes (e.g. speed-dial keys can be used), but this may require additional SIP licenses depending on the SIP provider.

To configure additional page extensions (up to 50) click "Enable" beside the target extension and enter the Extension, Authentication ID, and Authentication password.

The 8301 will auto-answer any inbound calls received on these numbers and provide a voice paging path and multicast if configured. Note that only a single call can be active at a time.

Note: Some SIP phone systems may not support this feature if they limit the number of extensions that can be registered on a single device.

Additional Features Tab – More Ring Extensions

Status Basic Settings **Additional Features** Scheduler Advanced Settings System Logout

Input/Output Emergency Alerts More Page Extensions **More Ring Extensions**

More Ring Extensions

i This section allows additional extensions to be registered for the purpose of providing loud ringing alerts for more than one line. Unique ring tones can be selected for each line to allow them to be easily distinguished - for example a "Sales" line could have a different ring tone from a personal line. Appropriate call routing must be configured on your SIP phone system of course in order to trigger it to send calls to these different numbers.

i The 8301 will detect inbound ring events on these numbers and play the alerting tone until the inbound call stops ringing. It will not answer the calls in this mode.

i Note: Some SIP phone systems may not support this feature if they limit the number of extensions that can be registered on a single device.

Ring Extension 2	<input checked="" type="radio"/> Enabled <input type="radio"/> Disabled
Extension	<input type="text"/>
Authentication ID	<input type="text"/>
Authentication Password	<input type="password"/>
Display Name (Optional)	<input type="text"/>
Ring Tone	<Use Default Ring Tone>
Multicast Zone	<Use Default Multicast Zone>
Ring Extension 3	<input type="radio"/> Enabled <input checked="" type="radio"/> Disabled
Ring Extension 4	<input type="radio"/> Enabled <input checked="" type="radio"/> Disabled
Ring Extension 5	<input type="radio"/> Enabled <input checked="" type="radio"/> Disabled
Ring Extension 6	<input type="radio"/> Enabled <input checked="" type="radio"/> Disabled
Ring Extension 7	<input type="radio"/> Enabled <input checked="" type="radio"/> Disabled
Ring Extension 8	<input type="radio"/> Enabled <input checked="" type="radio"/> Disabled
Ring Extension 9	<input type="radio"/> Enabled <input checked="" type="radio"/> Disabled
Ring Extension 10	<input type="radio"/> Enabled <input checked="" type="radio"/> Disabled

Save

Up to 10 SIP Ring extensions can be registered. To configure additional ring extensions, click "Enable" beside the target extension and enter the Extension, Authentication ID, and Authentication Password. A unique Ring Tone and Multicast Zone can be assigned to each extension if desired.

Web Interface Scheduler

Scheduler Tab – Calendar

The Scheduler can be deployed along with Algo IP speakers, paging adapters and strobes to provide bell scheduling and automated announcements.

Calendar Schedules Data

Wed 19 Feb, 2020 22:20:49 (System Time)

Today < > February 2020 Save

Schedule: Friday All Weekdays All

Sunday	Monday	Tuesday	Wednesday	Thursday	Friday	Saturday
						1
2	3: Regular Weekday	4: Regular Weekday	5: Regular Weekday	6: Regular Weekday	7: Friday	8
9	10: Regular Weekday	11: Regular Weekday	12: Regular Weekday	13: Regular Weekday	14: Friday	15
16	17: Regular Weekday	18: Regular Weekday	19: Regular Weekday	20: Regular Weekday	21: Friday	22
23	24: Regular Weekday	25: Regular Weekday	26: Regular Weekday	27: Regular Weekday	28: Friday	29

Once a bell schedule has been configured in the Schedules tab (see below), it can be added to the desired dates on the calendar. Multiple different schedules can be created. For example, Fridays might have a different schedule than the other weekdays.

From the drop down menu at the top of the calendar, select a schedule (e.g. Regular weekday), then click on the calendar dates to implement the schedule. When finished, click Save.

To clear the schedule from the entire month, select **None (clear)** from the drop down menu, and click on the dates to clear.

“All Weekdays” or “All” buttons can be used instead of clicking individual dates to implement a specific schedule throughout the month or to clear existing schedule for the whole month.

The schedule will need to be applied to each month separately.

Scheduler Tab – Schedules

Calendar | Schedules | Data

Wed 19 Feb, 2020 22:27:40 (System Time)

Schedule Name	Colour in Calendar
<input type="button" value="x"/> <input type="button" value="c"/> Regular Weekday	<input type="button" value="x"/> <input type="button" value="c"/>
<input type="button" value="x"/> <input type="button" value="c"/> Friday	<input type="button" value="x"/> <input type="button" value="c"/>

Current Schedule: **Regular Weekday**

Description	Time	Audio	Page Zone
<input type="button" value="x"/> <input type="button" value="c"/> Lunch bell	<input type="button" value="x"/> <input type="button" value="c"/> 12:00:00	<input type="button" value="x"/> <input type="button" value="c"/> bell-na.wav	<input type="button" value="x"/> <input type="button" value="c"/> 1

Click to add a bell schedule that will be implemented on specific calendar days. Give a **Schedule Name** and pick a **Colour in Calendar** to represent the schedule on the calendar.

Select the schedule, and in the **Current Schedule** section, add events (bells) to the schedule. Specify the event **Description**, **Time**, **Audio** files to be played, and the **Page Zone**.

The chosen audio file will be played locally (e.g. amplifier connected to the 8301) and/or over the network via multicast to all other Algo endpoints (e.g. 8186, 8188, 8180, 8128, etc.) or RTP multicast compatible third-party equipment that are configured as Slaves on this zone.

- Delete schedule or event button
- Copy event button

 *Note: Any given calendar day can have one schedule assigned. Each schedule may contain up to 500 events (bells) and up to 30 schedules may be created.*

Scheduler Tab – Data

The screenshot shows a web interface with a top navigation bar containing tabs: Status, Basic Settings, Additional Features, Scheduler (selected), Advanced Settings, System, and Logout. Below this is a sub-navigation bar with tabs: Calendar, Schedules, and Data (selected). The main content area is titled "Scheduler Data" and contains a section labeled "Backup / Restore Data". This section has three rows of controls: 1. "Download Scheduler Data File" with a "Download" button. 2. "Restore Scheduler Data File" with a "Browse..." button, a "No file selected." status indicator, and a "Restore" button. 3. "Clear All Data" with a "Clear" button.

Download

Allows a back up of the schedule with events, times and calendar dates to be downloaded for backup purposes. Note that this backup is independent from the rest of the configuration backup on the device.

Restore

Upload and restore a saved Scheduler data file.

Clear All Data

Clears all the Scheduler data, including saved schedules and set calendar dates.

Web Interface Advanced Settings

Advanced Settings Tab - Network

Status
Basic Settings
Additional Features
Scheduler
Advanced Settings
System
Logout

Network
Admin
Users
Time
Provisioning
File Manager
Advanced Audio
Advanced SIP
Advanced Multicast

Network Settings

Network Interface

Protocol Static IP DHCP

IP Address

Netmask

Gateway

DNS Server 1

DNS Server 2

802.1Q Virtual LAN

VLAN Mode None Manual Auto

VLAN ID
[?](#) Value range: 0 to 4094

VLAN Priority
[?](#) Value range: 0 to 7

802.1X Port-based Network Access Control

802.1X Authentication Enabled Disabled

ID

Password [?](#)

Differentiated Services

SIP (6-bit DSCP value)
[?](#) Valid values range from 0 to 63

RTP (6-bit DSCP value)
[?](#) Valid values range from 0 to 63

RTCP (6-bit DSCP value)
[?](#) Valid values range from 0 to 63

DNS

DNS Caching Mode Disabled SIP All
[?](#) In "SIP" mode, only the results of DNS queries for SIP requests will be cached. In "All" mode, the results of all DNS queries will be cached.

Save

Protocol

DHCP is an IP standard designed to make administration of IP addresses simpler. When selected, DHCP will automatically configure IP addresses for each 8301 on the network. Alternatively, the 8301 can be set to a static IP address.

VLAN Mode

Enables or Disables VLAN Tagging. VLAN Tagging is the networking standard that supports Virtual LANs (VLANs) on an Ethernet network. The standard defines a system of VLAN tagging for Ethernet frames and the accompanying procedures to be used by bridges and switches in handling such frames. The standard also provides provisions for a quality of service prioritization scheme commonly known as IEEE 802.1p and defines the Generic Attribute Registration Protocol.

VLAN ID

Specifies the VLAN to which the Ethernet frame belongs. A 12-bit field specifying the VLAN to which the Ethernet frame belongs. The hexadecimal values of 0x000 and 0xFF are reserved. All other values may be used as VLAN identifiers, allowing up to 4094 VLANs. The reserved value 0x000 indicates that the frame does not belong to any VLAN; in this case, the 802.1Q tag specifies only a priority and is referred to as a priority tag. On bridges, VLAN 1 (the default VLAN ID) is often reserved for a management VLAN; this is vendor specific.

VLAN Priority

Sets the frame priority level. Otherwise known as Priority Code Point (PCP), VLAN Priority is a 3-bit field which refers to the IEEE 802.1p priority. It indicates the frame priority level. Values are from 0 (lowest) to 7 (highest).

802.1x Authentication

Credentials to access LAN or WLAN that have 802.1X network access control (NAC) enabled. This information will be available from the IT Administrator.

Differentiated Services (6-bit DSCP value)

Provides quality of service if the DSCP protocol is supported on your network. Can be specified independently for SIP control packets versus RTP and RTCP audio packets.

DNS Caching Mode

In "SIP" mode, only the results of DNS queries for SIP requests will be cached. In "All" mode, the results of all DNS queries will be cached.

Advanced Settings Tab – Admin

The screenshot displays the 'Advanced Settings' tab for the 'Admin' user. The interface includes a navigation bar at the top with tabs for Status, Basic Settings, Additional Features, Scheduler, **Advanced Settings**, System, and Logout. Below the navigation bar, there are sub-tabs for Network, **Admin**, Users, Time, Provisioning, File Manager, Advanced Audio, Advanced SIP, and Advanced Multicast.

The main content area is titled 'Admin Settings' and is organized into several sections:

- Admin Password:** Fields for 'Password' and 'Confirmation' with eye icons for visibility toggling.
- General:**
 - Device Name (Hostname):
 - Introduction Section on Status Page: On Off
 - Show Status Section on Status Page when Logged Out: On Off
 - Web Interface Session Timeout: (Note: Automatically log out web interface after period of inactivity.)
 - Play Tone at Startup: Enabled Disabled (Note: A tone can be played at startup to confirm that the device has booted. This can be useful when testing or configuring a device, but might not be desirable if the device is connected to an external amplifier and paging system.)
- Log Settings:**
 - Log Level: Error (Lowest) Notice ("Event") Info ("SIP") Debug (Highest)
 - Log Method: Local Network Both
- Management:**
 - Web Interface Protocol: Both HTTP and HTTPS HTTPS Only
 - Force Strong Password: Enabled Disabled
 - Allow Secure SIP Passwords: Enabled Disabled (Note: After enabling this option, it is recommended to re-enter SIP passwords and their corresponding realm to store the passwords securely.)
 - SNMP Support: Enabled Disabled (Note: Download MIB file [here](#).)
- System Integrity:**
 - System Integrity Checking: Enabled Disabled (Note: This feature verifies installed system packages to ensure they have not been tampered with. Enabling this feature may cause reboots and upgrades to take 30 seconds longer. Verification results can be found on the Status page.)
- Syn-Apps:**
 - SA-Announce Support: Enabled Disabled
 - SA-Announce Server: (Note: Leave this field blank to use the server provided by DHCP Option 72.)
 - Local Management Port:
- InformaCast:**
 - InformaCast Support: Enabled Disabled (Note: This feature requires a valid license to be activated. Please contact sales@algosolutions.com for assistance.)

A green 'Save' button is located at the bottom right of the settings page.

Password

Password to log into the 8301 Paging Adapter & Scheduler web interface. You should change the default password **algo** in order to secure the device on the network. If you have forgotten your password, you will need to perform a reset using the Reset Button in order to restore the password (as well as all other settings) back to the original factory default conditions.

For additional password security see "Force Strong Password" below.

Confirmation

Re-enter network admin password.

Device Name (Hostname)

Name to identify the device in the Algo Network Device Locator Tool.

Introduction Section on Status Page

Allows the introduction text to be hidden from the login screen.

Show Status Section on Status Page when Logged Out

Use this option if you wish to block access to the status page when logged out. The settings and configurations, on the status page, will be hidden entirely unless you're logged in – this feature is useful when you want only trusted users to view possible sensitive device information.

Web Interface Session Timeout

Set the maximum period of inactivity after which the web interface will log out automatically.

Play Tone at Startup

A tone can be played at startup to confirm that the device has booted.

Log Level

Use on the advice of Algo technical support only.

Log Method

Allows the 8301 to write to external Syslog server if the option for external (or both) is selected.

Log Server

If "Network" or "Both" is selected this is the address of the Syslog server on the network.

Web Interface Protocol

HTTPS is always enabled on the device. Use "HTTPS Only" mode to disable HTTP, then requests will be automatically redirected to HTTPS. Also note that since the device can have any address on the local network, no security certificate exists, and thus most browsers will provide a warning when using HTTPS.

Force Strong Password

When enabled, ensures that a secure password is provided for the device's web interface for additional protection. The password requirements are:

- Must contain at least 10 characters
- Must contain at least 1 uppercase character
- Must contain at least 1 digit (0 – 9)
- Must contain at least 1 special character

Allow Secure SIP Password

Allows SIP passwords to be stored in the configuration file in an encrypted format, to prevent viewing and recovery. Once enabled, the SIP “Realm” field should be entered and all the configured Authentication Password(s) must be re-entered in the Basic Settings > SIP tab, and any other locations where SIP extensions have been configured, to save the encrypted password(s).

If the Realm is changed at a later time, all the passwords will also need to be re-entered again to save the passwords with the new encryption.

To obtain your SIP Realm information, contact your SIP Server administrator (or check the SIP log file for a registration attempt). The Realms may be the same or different for all the extensions used.

SNMP Support

Additional SNMP support is anticipated for future. Currently the 8301 will respond to a simple status query for automated supervision. Contact Algo technical support for more information.

System Integrity Checking

This feature verifies installed system packages to ensure they have not been tampered with by running ‘Perform Check’. Enabling this feature may cause reboots and upgrades to take 30 seconds longer. Verification results can be found on the Status page.

SA-Announce Support

Syn-Apps SA-Announce paging application converts unicast streams to multicast and delivers them to the target endpoints. The feature can only be used on the 8301 when Multicast Master Mode is disabled (set to ‘None’) in the Basic Settings > Multicast tab.

SA-Announce Server

Enter the SA-Announce Server to use the Syn-Apps paging feature. To use the server provided by the DHCP Option 72, leave the field blank.

Local Management Port

Enter the local management port for the SA-Announce Server.

InformaCast Support

This feature requires a valid InformaCast license to be activated. Please contact sales@algosolutions.com for assistance.

Advanced Settings Tab – Users

The screenshot shows the 'Advanced Settings' tab for 'Users'. The 'Scheduler' section is expanded, showing a form with the following fields:

- User Login:** Radio buttons for 'Enabled' and 'Disabled'. 'Disabled' is selected.
- Username:** Text input field containing 'Scheduler'.
- Password:** Password input field with masked characters and a refresh icon.

A 'Save' button is located at the bottom right of the form.

A separate login account with limited access can be set up. The user will only be able to modify the device scheduler.

Advanced Settings Tab – Time

Network time is used for logging events into memory for troubleshooting.

The screenshot shows the 'Advanced Settings' tab for 'Time'. The 'Time Settings' section is expanded, showing the following fields:

- Timezone:** Dropdown menu set to 'UTC'.
- NTP Time Server 1:** Text input field containing '0.debian.pool.ntp.org'.
- NTP Time Server 2:** Text input field containing '1.debian.pool.ntp.org'.
- NTP Time Server 3:** Text input field containing '2.debian.pool.ntp.org'.
- NTP Time Server 4:** Text input field containing '3.debian.pool.ntp.org'.
- NTP Time Server Source:** Radio buttons for 'Use DHCP Option 42' (selected) and 'Ignore DHCP Option 42'. A note below states: "By default, if an NTP Server address is provided via DHCP Option 42, this will be used instead of the options above."
- Device Date/Time:** Text input field showing 'Wed Feb 19 23:06:46 2020' and a 'Sync with browser' button. A note below states: "Manual time and date are intended for testing purpose only. Time will be lost upon power down."

A 'Save' button is located at the bottom right of the form.

Timezone

Select time zone.

NTP Time Servers 1/2/3/4

The interface will attempt to use Timer Server 1 and work down the list if one or more of the time servers become unresponsive.

NTP Time Server Source

When “Use DHCP Option 42” is chosen, if an NTP Server address is provided via the DHCP Option 42, that NTP Server will be used instead of the 4 mentioned above. Alternatively, “Ignore DHCP Option 42” can be chosen to only use servers mentioned above.

Device Date/Time

This field shows the current time and date as set on the device. If testing the device on a lab network that may not have access to an external NTP server, the “Sync with browser” button can be used to temporarily set the time on the device.

 *Note: This time value will be lost at power down, or overwritten if NTP is currently active. Time and date are used for logging purposes and for the scheduler feature.*

Advanced Settings Tab – Provisioning

Provisioning Settings

Mode

Provisioning Mode Enabled Disabled

Settings

Server Method Auto (DHCP Option 66/160/150)
 DHCP Option 66 only
 DHCP Option 160 only
 DHCP Option 150 only
 Static
i Auto mode automatically checks all 3 DHCP options for an active provisioning server, in the order listed.

Static Server

Download Method TFTP FTP HTTP HTTPS

Validate Server Certificate Enabled Disabled

Auth User Name

Auth Password 

Config Download Path

Firmware Download Path

Partial Provisioning Enabled Disabled
i Allow support for "-i" incremental provisioning files. Disable for enhanced security if not using this feature.

 *Note: It is recommended that Provisioning Mode be set to Disabled if this feature is not in use. This will prevent unauthorized re-configuration of the device if DHCP is used.*

Provisioning allows installers to pre-configure the 8301 Paging Adapter & Scheduler units prior to installation on a network. It is typically used for large deployments to save time and ensure consistent setups.

The device can be provisioned via the Auto mode (where all three DHCP options (Option 66/160/150) will be automatically checked for an active provisioning server), just one of the three specified DHCP options, or a Static Server. In addition, there are four different ways to download provisioning files from a "Provisioning Server": TFTP (Trivial File Transfer Protocol), FTP, HTTP, or HTTPS.

For example, the 8301 configuration files can be automatically downloaded from a TFTP server using DHCP Option 66. This option code (when set) supplies a TFTP boot server address to the DHCP client to boot from.



Important: DHCP must be enabled if using DHCP Option 66/160/150, in order for Provisioning to work.

One of two files can be uploaded on the Provisioning Server (for access via TFTP, FTP, HTTP, or HTTPS):

Generic (for all Algo 8301 Paging Adapter & Scheduler) **algot8301.conf**

Specific (for a specific MAC address)

algot[MAC].conf

Both protocol and path is supported for Option 66, allowing for <http://myserver.com/config-path> to be used.

MD5 Checksum

In addition to the **.conf** file, an **.md5** checksum file must also be uploaded to the Provisioning server (for TFTP mode only). This checksum file is used to verify that the **.conf** file is transferred correctly without error.

A tool such as can be found at the website address below and may be used to generate this file: <http://www.fourmilab.ch/md5>

The application doesn't need an installation. To use the tool, simply unzip and run the application (md5) from a command prompt. The proper **.md5** file will be generated in the same directory.

If using the above tool, be sure to use the "-l" parameter to generate lower case letters.

Generating a generic configuration file

1. Connect the 8301 to the network
2. Access the 8301 Web Interface Control Panel
3. Configure the 8301 with desired options
4. Click on the System tab and then Maintenance.
5. Click "Download" to download the current configuration file
6. Save the file settings.txt
7. Rename file settings.txt to algot8301.conf

8. The file `algot8301.conf` can now be uploaded onto the Provisioning server. If using a generic configuration file, extensions and credentials have to be entered manually once the 8301 has automatically downloaded the configuration file.

Generating a specific configuration file

1. Follow steps 1 to 6 as listed in the section “Generating a generic configuration file”.
2. Rename file `settings.txt` to `algot[MAC address].conf` (e.g. `algot0022EE020009.conf`)
3. File `algot[MAC address].conf` can now be uploaded on the Provisioning server.

The specific configuration file will only be downloaded by the 8301 with the MAC address specified in the configuration file name. Since all the necessary settings can be included in this file, the 8301 will be ready to work immediately after the configuration file is downloaded. The MAC address of each 8301 can be found on the back label of the unit.

For more Algo SIP endpoint provisioning information, see:

www.algosolutions.com/provision

Advanced Settings Tab – File Manager

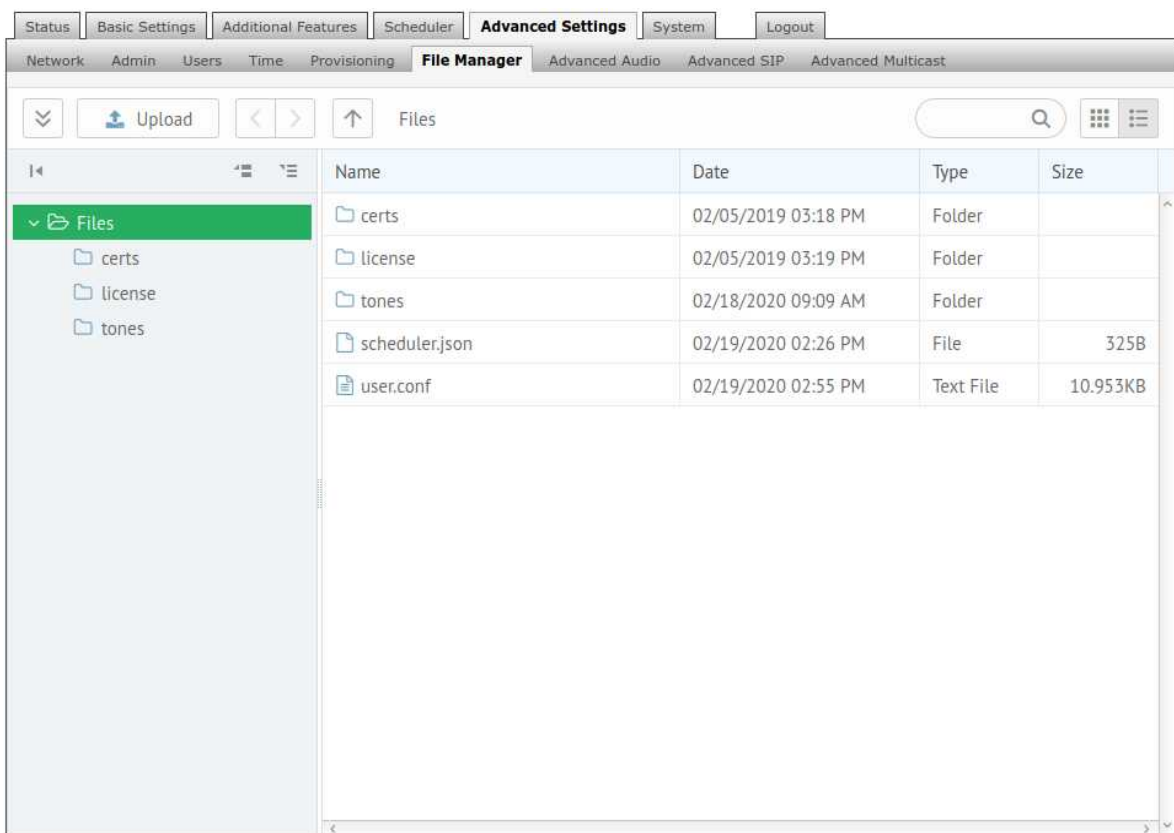

Uploading Custom Audio Files

Custom audio files may be uploaded into memory (1 GB) to play for notification applications. Place your audio files into the **tones** directory.

An existing file may also be modified. Download the original file and right clicking the tone and selecting 'Download', making the desired changes, and then uploading the new version with a different name. Audio files must be in the following format:

- WAV format
- 8kHz or 16kHz sampling rate
- 16-bit PCM, or u-law
- Mono
- Smaller than 200MB

File names must be limited to 32 characters, with no spaces.

For further instructions reference the [Custom Tone Conversion and Upload Guide](#).

Tone Files Included in Memory

The 8301 Paging Adapter & Scheduler includes several pre-loaded audio files that can be selected to play for various events. The web interface allows selection of the file and also the ability to play the it immediately over the speaker for testing (available in Basic Settings > Features tab). Files may also be deleted or renamed.

Advanced Settings Tab – Advanced Audio

The screenshot shows the 'Advanced Audio Functions' configuration page. At the top, there are navigation tabs: Status, Basic Settings, Additional Features, Scheduler, **Advanced Settings**, System, and Logout. Below these are sub-tabs: Network, Admin, Users, Time, Provisioning, File Manager, **Advanced Audio**, Advanced SIP, and Advanced Multicast. The main content area is titled 'Advanced Audio Functions' and is divided into two sections: 'Functions' and 'Audio Filters'.
Functions Section:
 - Dynamic Range Compression (DRC): Enabled Disabled. Info: Compress the dynamic range of page audio to increase loudness.
 - Dynamic Range Compression Gain: 6 (dropdown). Info: Specify the amount of compression gain. More gain increases distortion.
 - Jitter Buffer Range (milliseconds, 10 ~ 500): 100 (input field). Info: Adds more buffering if necessary to correct for inconsistent delays on the network. Use of the lowest value generally is recommended.
 - Generate In-Band DTMF Tones: Enabled Disabled. Info: Play DTMF tones during a SIP Call to allow interoperability with DTMF-controlled multi-zone amplifiers.
 - Always Send RTP Media: Enabled Disabled.
Audio Filters Section:
 - Speaker Filter: None (dropdown). Info: Bandwidth also limited by audio codecs.
 - Speaker Noise Filter: Enabled Disabled. Info: Aggressive 8th order Elliptical Filter (fc = 145Hz).
 - Microphone Filter: None (dropdown).
 - Microphone Noise Filter: Enabled Disabled. Info: Aggressive 8th order Elliptical Filter (fc = 145Hz).
 A 'Save' button with a green checkmark is located at the bottom right of the configuration area.

Dynamic Range Compression (DRC)

If enabled, compresses the dynamic range of page audio to increase loudness.

Dynamic Range Compression Gain

Higher compression gain increases distortion.

Jitter Buffer Range

The jitter buffer removes the jitter in arriving network packets by temporarily storing them. This process corrects the inconsistent delays on the network. It is recommended to use the lowest value.

Generate In-Band DTMF Tones

If enabled, plays DTMF tones to the analog output during a SIP call to allow interoperability with DTMF-controlled multi-zone amplifiers.

Always Send RTP Media

If enabled, audio packets will be sent at all times, even during one-way paging mode. This option is needed in cases when the server expects to see audio packets at all times.

Speaker Filter

Applies a high-pass filter to the speaker output. Used to reduce audio artifacts like humming or buzzing by filtering out unwanted frequencies.

Speaker Noise Filter

Enables heavy filtering below 145Hz to reduce mains induced noise (fans).

Microphone Filter

Applies a high-pass filter to the microphone input. Used to reduce audio artifacts like humming or buzzing by filtering out unwanted frequencies.

Microphone Noise Filter

Enables heavy filtering below 145Hz to reduce mains induced noise (fans).

Advanced Settings Tab – Advanced SIP

Status Basic Settings Additional Features Scheduler **Advanced Settings** System Logout

Network Admin Users Time Provisioning File Manager Advanced Audio **Advanced SIP** Advanced Multicast

Advanced SIP Settings

General

SIP Transportation TLS

ⓘ Select Auto to check DNS NAPTR record, then try UDP/TCP.
 ⓘ In TLS mode, if the SIP Server requires endpoints to be authenticated, a PEM file containing both a device certificate and a private key needs to be installed on the Algo device. Use the "Advanced Settings > File Manager" tab to upload a certificate file renamed to 'sipclient.pem' in the 'certs' folder.
 ⓘ To force the Algo device to authenticate the SIP server, a certificate obtained from the SIP server needs to be installed. Use the "Advanced Settings > File Manager" tab to upload a certificate file renamed to 'siptrusted.pem' in the 'certs' folder.

SIPS Scheme Enabled Disabled

SDP SRTP Offer Disabled

SIP Outbound Support (RFC 5626) Enabled Disabled

ⓘ Enable this option to support best networking practices according to RFC 5626. This option should generally be enabled if the Algo device is being registered with a hosted server or if TLS is being used for SIP Transportation.

Outbound Proxy

Register Period (seconds)

NAT

Media NAT None ICE STUN

Server Redundancy

Server Redundancy Feature (Multiple SIP Server Support) Enabled Disabled

Backup Server #1

Backup Server #2

Polling Interval (seconds) 120 seconds (2 minutes)

ⓘ Time to wait between sending monitoring packets to each server. Inactive servers are always polled and the active server may optionally be polled (see below).

Poll Active Server Enabled Disabled

ⓘ Explicitly poll the current server to monitor its availability. Polling may also be handled automatically by other regular events, so this can be disabled to reduce network traffic.

Automatic Failback Enabled Disabled

ⓘ Reconnect with a higher priority server once available, even if the backup connection is still working.

Polling Method SIP NOTIFY SIP OPTIONS

ⓘ SIP message used to poll servers in order to monitor their availability.

Interoperability

Keep-Alive Method None Double CRLF

ⓘ This setting will enable sending periodic CRLF messages for both UDP and TCP connections.

Use Outgoing TLS port in SIP headers Enabled Disabled

ⓘ Use ephemeral port number from outgoing SIP TLS connection instead of listening port number in SIP Contact and Via headers. This is useful to connect the device to some local SIP servers, like Asterisk or FreeSWITCH.

Do Not Reuse Authorization Headers Enabled Disabled

ⓘ When enabled, all SIP authorization information from the last successful request will not be reused in the next request.

Save

SIP Transportation

Which transport layer protocol to use for SIP messages. Setting 'SIP Transportation' to 'TLS', ensures the encryption of SIP traffic.

SIPS Scheme

Only visible when 'SIP Transportation' set to 'TLS'. Enabling SIPS Scheme requires the SIP connection from endpoint to endpoint to be secure.

SDP SRTP Offer

Setting 'SDP SRTP Offer' to 'Optional', means the SIP call's RTP data will be left unencrypted if the other party does not support SRTP. Setting 'SDP SRTP Offer' to 'Standard', encrypts RTP voice data, meaning the normal audio RTP packets will now be secure (SRTP). This means SIP calls will be rejected if other party does not support SRTP. The 'Standard' option secures the audio data between parties, by making sure that it's not left out in the open for third parties to later reconstruct and listen to.

SIP Outbound Support (RFC 5626)

Enable this option to support best networking practices according to RFC 5626. This option should generally be enabled if the Algo device is being registered with a hosted server or if TLS is being used for SIP Transportation.

Outbound Proxy

IP address for outbound proxy. A proxy (server) stands between a private network and the internet.

Register Period (seconds)

Maximum requested period of time where the 8301 will re-register with the SIP server. Default setting is 3600 seconds (1 hour). Only change if instructed otherwise.

Media NAT

IP address for STUN server if present or IP address/credentials for a TURN server.

Server Redundancy Feature

Two secondary SIP servers may be configured. The 8301 will attempt to register with the primary server but switch to a secondary server when necessary. The configuration allows re-registration to the primary server upon availability or to stay with a server until unresponsive.

If Server Redundancy is selected the web page will expand as shown below.

Backup Server #1

If the primary server is unreachable the 8301 will attempt to register with the backup servers. If enabled, the 8301 will always attempt to register with the highest priority server.

Backup Server #2

If backup server #1 is unreachable the 8301 will attempt to register with the 2nd backup server. If enabled, the 8301 will always attempt to register with the highest priority server.

Polling Intervals (seconds)

Time period between sending monitoring packets to each server. Non-active servers are always polled, and active server may optionally be polled (see below).

Poll Active Server

Explicitly poll current server to monitor availability. May also be handled automatically by other regular events, so can be disabled to reduce network traffic.

Automatic Fallback

Reconnect with higher priority server once available, even if backup connection is still fine.

Polling Method

SIP message used to poll servers to monitor availability.

Keep-alive Method

If Double CRLF is selected the 8301 will send a packet every 30 seconds (recommended value) to maintain connection with the SIP Server if behind NAT.

Keep-alive Interval

Interval in seconds that the CRLF message should be sent.

Use Outgoing TLS port in SIP headers

Use ephemeral port number from outgoing SIP TLS connection instead of listening port number in SIP Contact and Via headers. This is useful to connect the device to some local SIP servers, like Asterisk or FreeSWITCH.

Do Not Reuse Authorization Headers

When enabled, all SIP authorization information from the last successful request will not be reused in the next request.

Allow Missing Subscription-State Headers

When enabled, allow SIP NOTIFY messages that do not contain a "Subscription-State" header.

Advanced Settings Tab – Advanced Multicast

Status
Basic Settings
Additional Features
Scheduler
Advanced Settings
System
Logout

Network
Admin
Users
Time
Provisioning
File Manager
Advanced Audio
Advanced SIP
Advanced Multicast

Advanced Multicast Settings

i Current multicast mode: Master
 Multicast mode can be set in "Basic Settings > Multicast"

Master Settings

Master Output Codec: G.711 ulaw

Master Output Packetization Time (milliseconds): 20

RTP Control Protocol (RTCP)

RTCP Port Selection: Disabled Next Higher Port Multiplexed on Same Port

i Select the port on which packets will be sent or received.
 If using the 'Next Higher Port' option, ensure that the default multicast zone definitions are modified such that zones are only assigned to even-numbered ports, leaving the next higher odd-numbered ports free for RTCP packets.

Basic Zone Definition

Zone	IP Address and Port	Page Tone
Priority Call (DTMF:9)	224.0.2.60:50000	<Use Default Page Tone>
All Call (DTMF:0/8)	224.0.2.60:50001	<Use Default Page Tone>
Zone 1 (DTMF:1)	224.0.2.60:50002	<Use Default Page Tone>
Zone 2 (DTMF:2)	224.0.2.60:50003	<Use Default Page Tone>
Zone 3 (DTMF:3)	224.0.2.60:50004	<Use Default Page Tone>
Zone 4 (DTMF:4)	224.0.2.60:50005	<Use Default Page Tone>
Zone 5 (DTMF:5)	224.0.2.60:50006	<Use Default Page Tone>
Zone 6 (DTMF:6)	224.0.2.60:50007	<Use Default Page Tone>
Music (DTMF:7)	224.0.2.60:50008	<Use Default Page Tone>

Expanded Zone Definition

Zone	IP Address and Port	Page Tone
Zone 10 (DTMF: *10)	224.0.2.110:50000	<Use Default Page Tone>
Zone 11 (DTMF: *11)	224.0.2.111:50000	<Use Default Page Tone>



Note: The settings on this tab are only visible when in master or slave multicast mode.

The default prepopulated multicast addresses above will work in most cases and should only be altered for rare cases.

Audio Sync (Slave Mode)

When using multicast with other third-party devices that have a delay in their audio path, the audio on the 8301 may be heard slightly earlier than on these other devices. By adding audio delay up to one second, the 8301 may be synchronized with other speakers or telephones that have greater latency. This feature applies to Multicast Slave mode only.

Master Output Codec (Master Mode)

Audio encoding format used by the Master device when sending output to the slaves.

Master Output Packetization Time (Master Mode)

The size of the audio packets sent by the Master to the Slaves. The default of 20ms is recommended, unless a different value is specifically required for compatibility with other devices.

RTCP Port Selection

Select the port on which RTCP packets will be sent or received. If using the 'Next Higher Port' option, ensure that the default multicast zone definitions are modified such that zones are only assigned to even-numbered ports, leaving the next higher odd-numbered ports free for RTCP packets.

Zone Definition

The "Expanded" Slave zones can be enabled/disabled in Basic Settings > Multicast. Default IP addresses and ports may be revised for any given zone in the table.



Important: Ensure that the Address and Port settings are the same for all master and slave devices.

Page Tone and Page Volume

Master Mode: By default, the same tone can be set for all Slave zones in the Basic Settings > Features tab. Unique paging tones may be revised for any given zone in the table above.

Slave Mode: When an Algo device is the multicast Master, a page tone will play on the Slave device, so it is recommended to set the Slave tone to "None". If a page is received from a non-Algo device that doesn't send a tone, a tone can be inserted on the Slaves (above) each time they detect page audio starting, allowing them to play a tone.

By default, the same page volume can be set for all Slave zones in the Basic Settings > Features tab. Unique page volumes may be revised on a per-zone basis in the table above. For instance, emergency pages can be louder on certain Slave speakers.

Polycom Slave Tones

Available if Multicast Slave and "Polycom Group Page" or "Polycom Push-to-Talk" are selected in the Basic Settings > Multicast tab. A tone may be set for any of the 25 Polycom Groups. If using an Algo device as a Multicast master, it is recommended to set the slave tones to "None" to avoid conflicts, as the Algo devices already multicast a tone by default.

Web Interface System

System Tab - Maintenance

Download Configuration File

Save the device settings to a text file for backup or to setup a provisioning configuration file.

Restore Configuration File

Restore settings from a backup file.

Restore Configuration to Defaults

Resets all 8301 Paging Adapter & Scheduler device settings to factory default values.

Download Backup Zip File

Saves the device settings (configuration) and all the files in File Manager: certificates, licenses, and tones to a backup zip file.

Restore from Backup Zip File

Restores the device settings (configuration) and all the files in File Manager: certificates, licenses, and tones from a backup zip file.

Restore All Settings and Files to Defaults

Resets the device settings (configuration) and all the files in File Manager: certificates, licenses, and tones to factory default values.

Reboot the Device

Reboots the device.

Method

For firmware upgrades. Specify whether the firmware files will be downloaded from the local computer or a remote URL.

Firmware Image

Point to the firmware image provided by Algo.

MD5 Checksum

Point to the checksum file provided by Algo.

How to upgrade the 8301 Paging Adapter & Scheduler Firmware

1. From the top menu, click on System, then Maintenance.
2. In the Upgrade section, click on Choose File and select the 8301 firmware file to upload. Note that both FW firmware and MD5 checksum files must be loaded.
3. Click Upgrade
4. After the upgrade is complete, confirm that the firmware version has changed (refer to top right of Control Panel).

System Tab – System Log

System log files are automatically created and assist with troubleshooting in the event the 8301 Paging Adapter & Scheduler does not behave as expected.

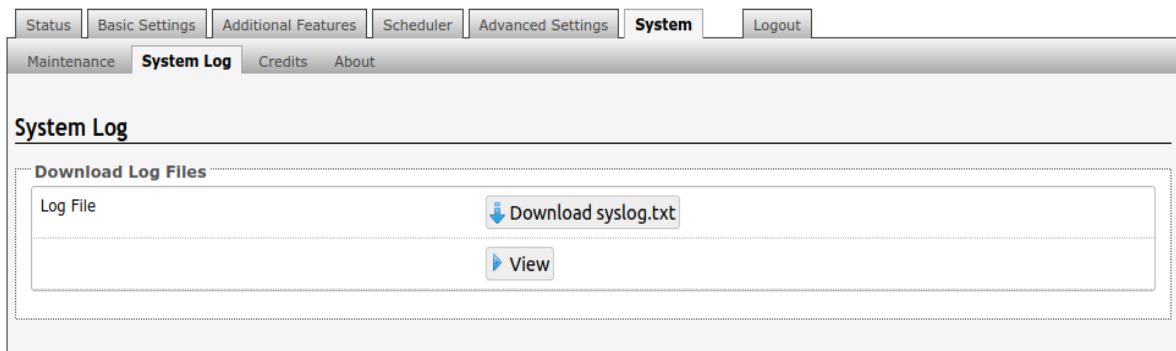

Specifications

Power Input:	PoE (IEEE 802.3af Class 0) 48V, 12.95W (Max 4 W - Idle nominal 2W)
SIP:	SIP Extensions: <ul style="list-style-type: none">• 50 Page (Capable of hands-free talkback when appropriate speaker & microphone connected)• 10 Emergency Alert• 10 Ring SIP Signalling/Transport Protocols: UDP, TCP, TLS, RTP, SRTP
Multicast & Third-Party Compatibility:	RTP Multicast (Send and Receive 50 Zones) Polycom Group Page Singlewire InformaCast (additional license required) Syn-Apps Revolution
Configuration & Provisioning:	Configuration: Web interface or provisioning server Web Interface: HTTP, HTTPS Provisioning: TFTP, FTP, HTTP, HTTPS DHCP Options 66, 150, 160 Reboot via SIP 'check-sync' Supervision: Compatible with any third-party SNMP monitoring software or the Algo 8300 Controller.
Networking:	Networking: IPv4, DHCP, VLAN Link Layer: LLDP, CDP QoS: DSCP (SIP, RTP, RTCP) NAT: STUN, TURN, CRLF Keep Alive, SIP Outbound Address Resolution: DNS, SRV Record Redundancy: Secondary and tertiary SIP server Time: NTP Server (up to four)
Audio:	Audio Codecs: G.711 u-law, G.711 A-law, G.722 Wideband Audio Memory: 1 GByte audio storage
Input/Output:	Relay Input: Normally open or normally closed dry contact supervision using Algo 1202 Call Button, 1203 Call Switch, 1204 Volume Control, 1205 Audio Interface or EOL resistor termination Relay Output: Max 30 V 50 mA (normally open)

Relay Input Current Draw Detection Thresholds:

	Active	Idle	Tamper
Normally Open	>4mA	<4mA	N/A
Normally Open with Supervision	>20mA	4-20mA	<4mA
Normally Closed	<4mA	>4mA	N/A
Normally Closed with Supervision	4-20mA	>20mA	<4mA

Nominal 12V source, current limited to 40mA
Typical supervision resistor value = 1k ohm

Environmental & Mechanical:

Environmental: 0 to + 40° C (32 to 104° F); 10-95% RH non-condensing.

Dry indoor locations only.

Dimensions (Product): 6.75" x 4.3" x 1.18" (17.2 cm x 10.9 cm x 3.0 cm)

Weight (product): 0.95 lbs (0.4 kg)

Weight (shipping): 1.5 lbs (0.7 kg)

Compliance:

RoHS, CE, FCC Class A, CISPR 22 Class A, CISPR 24, CSA/UL (USA & Canada), EN60950

FCC Compliance Statement

This equipment has been tested and found to comply with the limits for a Class A digital device, pursuant to Part 15 of the FCC Rules. These limits are designed to provide reasonable protection against harmful interference when the equipment is operated in a commercial environment. This equipment generates, uses, and can radiate radio frequency energy, and if it is not installed and used in accordance with the instruction manual, it may cause harmful interference to radio communications. Operation of this equipment in a residential area is likely to cause harmful interference, in which case the user will be required to correct the interference at his own expense.